

Badile a punta



acciaio forgiato

53549

25 UM
NR € 10,73

Badile punta quadra



acciaio forgiato spalla cm.29

00965

25 UM
NR € 10,73

Badile a punta



acciaio temperato verniciato oro

04695 mis
00

12 UM
NR € 7,27

Badile punta quadra



acciaio stampato

	NR	SP	gr.	UM	€
02799	4	cm.29	850	25 NR	5,18
02798	6	cm.31	1050	25 NR	5,81

Badile a punta



acciaio temperato tropicalizzato

11428 MIS
00

16 UM
NR € 4,58

Badile punta tonda



acciaio forgiato

00966

25 UM
NR € 10,73

Badile a punta manicato



acciaio temperato verniciato oro con manico lucido bicolore

88051 mis
00

5 UM
NR € 15,00

Manico badile



curvo in legno cm.140

		UM	€
53554	pioppo	10 NR	3,92
50784	faggio	25 NR	3,43
00231	lucido	25 NR	5,25
50231	frassino	25 NR	4,77
08312	tipo svizzero	25 NR	6,54

Badile superleggero manicato



duralluminio manico lucido

88706 MIS
00

5 UM
NR € 21,93

Piccone



acciaio forgiato kg.1.5

81289

15 UM
NR € 11,44

Piccone



Acciaio di alta qualità forgiato e temprato kg.1,5

14820

1 UM
NR € 23,00

Piccone con manico



acciaio forgiato kg.1.5.manico in fibra di vetro

Articolo	KG	UM	€
87180	1,5	10 NR	33,07

Manico piccone



in legno cm.95

Articolo	UM	€
50230 faggio	25 NR	3,43
00227 frassino	25 NR	4,77
00224 seriate	25 NR	4,47

Manico piccone



in fibra di vetro cm.90

Articolo	UM	€
87181	12 NR	17,82

Raschifango



acciaio stampato

Articolo	cm	UM	€
51068	40	10 NR	7,21
51069	50	10 NR	9,20

Punta da muratore



acciaio temperato riaffilabile

Articolo	cm	UM	€
94732	25	6 NR	8,04
94733	30	6 NR	8,51
94734	35	6 NR	8,66
94735	40	6 NR	8,97

Scalpello da muratore



acciaio temperato riaffilabile

Articolo	cm	UM	€
94728	25	6 NR	8,04
94729	30	6 NR	8,51
94730	35	6 NR	8,66
94731	40	6 NR	8,97

Scalpello da muratore largo



acciaio temperato riaffilabile larghezza cm.7

Articolo	UM	€
94736	6 NR	11,70

Scalpello vidia



acciaio temperato color oro per graniti

Articolo	mm	UM	€
07463	8	1 NR	21,48
07464	10	1 NR	23,98
07465	12	1 NR	27,47
07466	15	1 NR	32,84
07467	20	1 NR	49,70
07468	25	1 NR	62,69
07469	30	1 NR	79,55

Punta elettricista



acciaio

Articolo	MM	UM	€
07508	200X10	10 NR	1,43
07509	250X10	10 NR	1,59

Scalpello elettricista



acciaio

Articolo	MM	UM	€
02803	200X10	10 NR	1,43
02804	250X10	10 NR	1,59

Martello da carpentiere



acciaio forgiato senza manico

Articolo	GR	UM	€
03425	250	1 NR	14,38
03424	350	1 NR	15,81
03426	450	1 NR	18,45

Martello da carpentiere



acciaio forgiato senza manico con calamita

Articolo	gr.	UM	€
11362	250	1 NR	17,37

Martello da carpentiere



acciaio forgiato con calamita e manico legno

Articolo	gr	UM	€
89130	250	6 NR	7,29
81239	300	6 NR	6,72
81240	400	6 NR	7,29

Martello da carpentiere



acciaio forgiato con manico in fibra di vetro cm.50

Articolo	gr	UM	€
89654	300	6 NR	7,87
89655	300 calamitato	6 NR	13,19

Martello da carpentiere



Manico TPR bicomponente in gomma e fibra di vetro cm.50 con collare di protezione - Testa lucidata in acciaio temperato con calamita

gr	UM	€
94264 300	1 NR	16,14
94265 400	1 NR	17,20

Manico per martello carpentiere



fibra di vetro per codici 94264 - 94265

cm	UM	€
94705 50	12 NR	6,69

Martello da muratore



acciaio forgiato con manico in fibra di vetro

gr	UM	€
92437 400	6 NR	10,58

Martellina Malepeggio



Manico TPR bicomponente in gomma e fibra di vetro da 380 mm. con collare di protezione - Testa nera a doppio taglio in acciaio forgiato temperato

gr	UM	€
94269 400	1 NR	13,87

Martellina Malepeggio



acciaio forgiato con manico legno

gr	UM	€
50065 400	6 NR	7,48

Martellina Malepeggio



acciaio forgiato con manico in fibra di vetro

GR.	UM	€
92438 400	6 NR	11,24

Martellina Catania



acciaio forgiato con manico legno

gr	UM	€
07445 400	6 NR	7,12

Martellina Catania



acciaio forgiato con manico in fibra di vetro

GR.	UM	€
92439 400	6 NR	8,60

Manico da carpentiere



fibra di vetro

cm	UM	€
89653 50	1 NR	4,09

Manico martello e martellina



fibra di vetro

MM.	UM	€
92443 380	10 NR	5,12

Manico per martello muratore



legno faggio

cm	gr	UM	€
04272 40	300/400	10 NR	1,25

Manico da carpentiere



legno rubinia

cm	gr	UM	€
04268 50	300	130 NR	2,74
04270 60	300	130 NR	3,07
04269 50	400	120 NR	2,74
04271 60	400	120 NR	3,07

Manico da carpentiere



legno di faggio lucido

cm	gr	UM	€
50078 45	300	10 NR	1,21

Portamartello acciaio



zincocromato con passante per cintura

	UM	€
51059	5 NR	1,37

Mazzetta muratore



testa ottagonale DIN 6475 manico legno bicolore

gr	cm	UM	€
87435 800	26	6 NR	6,60
87436 1000	26	6 NR	7,10

Mazzetta muratore con collare



testa ottagonale a norme DIN 6475 in acciaio forgiato C45, bloccaggio con cuneo tondo in acciaio, resina e collare sicurezza-salvamanico

gr	UM	€
00060 800	12 NR	9,86
00059 1000	12 NR	10,41

Mazzetta muratore con collare



testa ottagonale DIN 6475 acciaio forgiato temperato C45, manico in legno con collare salvamanico

gr	UM	€
88210 800	12 NR	6,80
88211 800	12 NR	7,08

Mazzetta muratore Fibra



testa ottagonale in acciaio forgiato, manico ergonomico antisdrucciolevole in TPR bicomponente gomma-fibra vetro

gr	UM	€
86607 800	6 NR	7,88
86608 1000	6 NR	9,38

Mazzetta Muratore Antisfilamento



Testa in acciaio forgiato temperato - Manico ergonomico antisdrucciolevole TPR bicomponente in gomma e fibra di vetro - Fissaggio conico antisfilamento

gr	UM	€
91553 800	7 NR	9,63

Mazzetta muratore



Manico TPR bicomponente in gomma e fibra di vetro con collare di protezione - Testa in acciaio forgiato - Spigoli smussati - A norme DIN 6475

gr	UM	€
94281 800	6 NR	13,26
94282 1000	6 NR	15,21

Manico per mazzette



fibra di vetro per codici 94281 - 94282

cm	UM	€
94710 28	10 NR	4,26

Manico mazzetta muratore



fibra di vetro cm.26

MM.	UM	€
92444 260	10 NR	3,34

Manico mazzetta muratore



legno cm.26

gr	UM	€
50080 800/1000	10 NR	1,19
50081 1200/1500	10 NR	1,23

Mazza ottagonale



acciaio forgiato senza manico

kg	UM	€
50069 3	1 NR	18,23
50070 4	1 NR	20,10
50071 5	1 NR	23,39

Mazza gemma



acciaio forgiato senza manico

kg	UM	€
50074 3	1 NR	18,95
50075 4	1 NR	21,25
50076 5	1 NR	26,21

Mazza a coppia manico Fibra



Manico TPR bicomponente in gomma e fibra di vetro con collare di protezione - Testa nera in acciaio forgiato e spigoli smussati - A norme DIN 6475 - Manico mm.900

kg	UM	€
94275 3	1 NR	39,63
94276 4	1 NR	48,36

Mazza spaccalegna



Manico TPR bicomponente in gomma e fibra di vetro cm.90 con collare di protezione - In acciaio forgiato

kg	UM	€
94278 3,6	1 NR	43,04
94277 2,7	1 NR	38,51

Manico per mazza



fibra di vetro per codici 94275 - 94276 - 94278 - 94279

cm	UM	€
94712 90	6 NR	19,28

Mazza a coppia



spigoli smussati acciaio forgiato con manico in fibra di vetro cm.90

KG.	UM	€
92440 3	1 NR	29,39
92441 4	1 NR	34,88

Manico mazza

 fibra di vetro cm.90

88216	1	UM NR	€ 17,82
-------	---	-------	---------

Manico mazza

 legno cm.95

50082 faggio	25	UM NR	€ 3,43
10628 frassino	25	UM NR	€ 4,17

Bocciarda a martello manicata



82886	1000	1	UM NR	€ 28,58
-------	------	---	-------	---------

Picozzino manico legno

 acciaio temperato

80189	600	24	UM NR	€ 9,36
-------	-----	----	-------	--------

Picozzino manico fibra di vetro

 acciaio temperato

86618	600	6	UM NR	€ 10,67
86619	800	6	UM NR	€ 12,63

Picozzino

 Manico TPR bicomponente in gomma e fibra di vetro cm.38 con collare di protezione - In acciaio temperato

94280	600	1	UM NR	€ 13,99
-------	-----	---	-------	---------

Picozzino con levachiodo

 acciaio temperato con manico legno mod.321

50083	600	1	UM NR	€ 35,05
-------	-----	---	-------	---------

Picozzino con martello

 acciaio temperato senza manico

03422	500	1	UM NR	€ 32,45
-------	-----	---	-------	---------

Manico legno per picozzini



00225 sagomato cm.45	1	UM NR	€ 3,43
07896 sagomato cm.60	1	UM NR	€ 4,29

Rabot per gesso

 in alluminio cm.46x8,5

05697	1	UM NR	€ 42,06
-------	---	-------	---------

Rabot per gesso

 in alluminio cm.45x8,5

92050	15	UM NR	€ 19,74
-------	----	-------	---------

Rabot per gesso mod.609

 in legno

52787	42X6	1	UM NR	€ 35,21
51055	47X7	1	UM NR	€ 41,56

Rabot per gesso

 manico e corpo in faggio evaporato e verniciato
lame in acciaio

17103	42x6	2	UM NR	€ 20,13
17104	42x7	2	UM NR	€ 20,45

Pialla per cartongesso

 manico in simil legno, supporto in plastica, lame in acciaio temperato con denti lisci

17101	27,5x12	4	UM NR	€ 15,34
-------	---------	---	-------	---------

Rasatore per intonaco



91723	250X145	38	5	UM NR	€ 7,25
-------	---------	----	---	-------	--------

Cazzuola punta tonda stretta 942/L

 manico Sintesi antiurto antiscivolo antivibrazione. Lama in acciaio temperato 15/10 a sezione variabile

02914	18	6	UM NR	€ 12,83
02915	19	6	UM NR	€ 13,01
02916	20	6	UM NR	€ 13,20
02917	21	6	UM NR	€ 13,55
02918	22	6	UM NR	€ 13,91
02919	23	6	UM NR	€ 14,28

Cazzuola punta tonda larga 941

 manico Sintesi antiurto antiscivolo antivibrazione. Lama in acciaio temperato 15/10 a sezione variabile.

02909	18	6	UM NR	€ 12,35
02910	19	6	UM NR	€ 12,57
02911	20	6	UM NR	€ 12,75
02912	21	6	UM NR	€ 13,11
02913	22	6	UM NR	€ 13,47

Cazzuola punta quadra 946



manico sintesi antiurto antiscivolo
antivibrazione. Lama in acciaio temperato 15/10
a sezione variabile

cm	UM	€
02904 18	6 NR	12,75
02905 19	6 NR	12,93
02906 20	6 NR	13,11
02907 21	6 NR	13,47
02908 22	6 NR	14,20

Cazzuola punta tonda stretta



acciaio temperato manico in legno

cm	UM	€
86542 18	12 NR	5,16
86543 20	12 NR	5,93
86544 21	12 NR	6,29
86545 22	12 NR	6,56

Cazzuola punta tonda larga



acciaio temperato manico legno

cm	UM	€
86772 18	12 NR	5,35
86773 20	12 NR	6,02
86774 22	12 NR	7,09

cazzuola punta quadra



acciaio temperato manico legno

cm	UM	€
86546 18	12 NR	5,16
86547 20	12 NR	6,00
86548 21	12 NR	5,78
86549 22	12 NR	7,09

Cazzuola punta tonda stretta



acciaio temperato manico bicomponente
antiscivolo

cm	UM	€
87813 18	12 NR	6,89
87814 20	12 NR	6,96
87815 21	12 NR	7,43
87816 22	12 NR	8,57

Cazzuola punta tonda larga



acciaio temperato manico bicomponente
antiscivolo

cm	UM	€
87823 18	12 NR	6,90
87824 20	12 NR	7,50
87825 22	12 NR	7,37

Cazzuola punta quadra



acciaio temperato manico bicomponente
antiscivolo

CM	UM	€
88115 16	12 NR	6,69
87817 18	12 NR	6,77
87818 20	12 NR	7,50
87819 21	12 NR	8,10
87820 22	12 NR	7,74

Cazzuolino punta tonda



acciaio temperato manico legno

cm	UM	€
51875 14	12 NR	3,48

Cazzuolino punta tonda



acciaio temperato manico bicomponente
antiscivolo

cm	UM	€
87826 14	12 NR	4,48

Cazzuola punta quadra



acciaio temperato manico legno

cm	UM	€
51876 14	12 NR	3,48

Cazzuolino punta acuta



acciaio temperato manico legno

cm	UM	€
51874 14	12 NR	3,35

Cazzuolino ad angolo

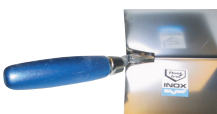

acciaio temperato manico legno

cm	UM	€
06836 100X75	1 NR	11,49

Frattone liscio 816/S



acciaio temperato manico plastica

cm	UM	€
52740 28X12	6 NR	12,74

Frattone liscio ECCELSA



cm.28x12 in acciaio temperato speciale.
Manico in materiale morbido antiscivolo e
antivibrazione.

	UM	€
13196	6 NR	15,18

Frattone dentato ECCELSA



cm.28x12 in acciaio temperato speciale.
Manico in materiale morbido antiscivolo e
antivibrazione.

mm	UM	€
13197 5x7	6 NR	15,96
13199 10x10	6 NR	15,96

Frattoni liscio Inox ECCELSA



cm.28x12 in acciaio temperato speciale. Manico in materiale morbido antiscivolo e antivibrazione.

	13200		UM	€
		6	NR	24,00

	MM	MOD		UM	€
87431	10X10	DX	12	NR	9,65

Frattoni liscio plastica 817/P



lama plastica Sicudor spessore mm.2.5 manico in plastica nero

	cm		UM	€
50026	28x13	6	NR	11,70

	CM.	MOD.		UM	€
91171	5X7	DX	12	NR	9,34
91173	10X10	DX	12	NR	9,34

Frattoni liscio plastica 817/RS



lama plastica Sicudorbianco rinforzato spessore mm.2. Manico Sintesi antiurto antiscivolo antivibrazione

	cm		UM	€
08937	28x13	6	NR	15,85

	cm		UM	€
91170	28x12	12	NR	8,88

Frattoni liscio Extra Lungo



in acciaio temperato speciale. Manico in materiale morbido antiscivolo e antivibrazione.

	cm		UM	€
13203	36x10	6	NR	15,03
13204	36x12	6	NR	19,32

		UM	€
55221	6	NR	11,25

Frattoni per cartongesso 845/ILR



in acciaio inox saldato con manico in Sintesi, attacco prolungato mm.297. Lama rastremata

	cm		UM	€
15914	36x10x0,5	6	NR	24,54

Frattoni a due mani liscio



acciaio temperato con manico in legno

	CM		UM	€
50024	48X14	6	NR	15,50

Frattoni due mani liscio 814



acciaio temperato manico in legno

	CM		UM	€
10302	48X14	6	NR	25,78
07247	48X12X0,52	6	NR	28,12

Frattoni a due mani dentato



acciaio temperato con manico in legno

	CM	mm		UM	€
52754	48X14	10X10	6	NR	14,37

Frattoni a due mani dentato 814/D



acciaio temperato manico in legno

	CM	MM		UM	€
10303	48X14	10X10	6	NR	27,40

Frattezza poliuretano



	cm		UM	€
52762	40X14	50	NR	5,52
52764	40X25	25	NR	7,37
52763	40X30	40	NR	7,75

Frattoni liscio 28x12



acciaio temperato manico in legno

	cm		UM	€
87428	28x12	12	NR	9,42

Frattezza plastica



	cm		UM	€
50036	45X15	50	NR	1,97
50034	42X26	30	NR	3,31
50035	42X30	30	NR	4,44

Frattoni dentato 28x12



acciaio temperato manico in legno

	MM	MOD		UM	€
87432	10X10	SX	12	NR	9,64

Spugna ricambio tabacco



spessore mm.40

Articolo	Dimensioni (cm)	UM	Prezzo (€)
09094	15x29x4	45 NR	4,89

Frattezza con attacco



per pulizia con innesto per manico, base in gommaspugna tabacco

Articolo	UM	Prezzo (€)
17102	30 NR	8,31

Vaschetta Roller It.23



cm.50x27 in plastica con rulli e ruote per la pulizia di pavimenti e rivestimenti

Articolo	Capacità (lt)	Dimensioni (cm)	UM	Prezzo (€)
91726	23	50X27	5 NR	42,81

Spatola manico legno 501



per stuccatori e pittori lama acciaio temperato

Articolo	Spessore (mm)	UM	Prezzo (€)
52802	20	12 NR	3,03
52241	30	12 NR	3,03
52242	40	12 NR	3,03
52243	50	12 NR	3,23
52244	60	12 NR	3,60
52245	70	12 NR	3,84
52246	80	12 NR	4,02
52247	100	12 NR	4,91
52804	120	12 NR	5,85

Spatola manico bicomponente



per stuccatori e pittori lama acciaio temperato

Articolo	Spessore (mm)	UM	Prezzo (€)
91175	30	12 NR	1,30
91176	40	12 NR	1,33
91177	50	12 NR	1,50
91178	60	12 NR	1,76
91179	80	12 NR	1,76
91180	100	12 NR	2,05

Spatola manico bicomponente inox



per stuccatori e pittori lama acciaio temperato

Articolo	Spessore (mm)	UM	Prezzo (€)
91181	40	12 NR	3,96
91183	60	12 NR	4,56
91184	80	12 NR	4,93
91185	100	12 NR	5,54

Spatola Rasatura



Spatola acciaio inox con inserto cacciavite per rasatura e lucidatura di stucco Veneziano e grassello di calce.

Articolo	Spessore (mm)	UM	Prezzo (€)
13201	100	12 NR	13,31
13202	120	12 NR	16,83

Spatola conica Greca 542



impugnatura tubolare dentata Greca spessore mm.0.5

Articolo	Spessore (mm)	UM	Prezzo (€)
52818	200	6 NR	7,21

Spatola conica Segra 542



impugnatura tubolare dentata Segra spessore mm.0.5

Articolo	Spessore (mm)	UM	Prezzo (€)
52251	200	6 NR	7,21

Spatola Milanese 539



lama blu spessore mm.0.30

Articolo	Spessore (mm)	UM	Prezzo (€)
02922	20	12 NR	0,33
52820	40	12 NR	0,67
51051	60	12 NR	1,02
51052	80	12 NR	1,31
51053	100	12 NR	1,74
51054	120	12 NR	2,19

Spatola Dentata 540



lama blu spessore mm.0.40 per Bostik

Articolo	Spessore (mm)	UM	Prezzo (€)
52815	40	12 NR	1,09
51508	60	12 NR	1,44
51509	80	12 NR	2,02
51510	100	12 NR	2,43

Raschietto per muro



senza manico lama acciaio temperato spessore lama mm.100x1

Articolo	Lama	Mod.	UM	Prezzo (€)
52801	riportata	611	6 NR	4,80
52798	fissa	610	6 NR	3,65

Spatola Milanese



Lama in acciaio blu - Idonea per lavori di carrozzeria e rasatura

Articolo	Spessore (mm)	UM	Prezzo (€)
55261	30	12 NR	0,29
55262	40	12 NR	0,34
55264	60	12 NR	0,62
55266	80	12 NR	0,80
55267	100	12 NR	0,92
55268	120	10 NR	0,96

Raschietto per muro



senza manico lama acciaio temperato spessore lama mm.1

Articolo	Spessore (mm)	UM	Prezzo (€)
06837	150X1	36 NR	12,35
06838	300X1	20 NR	16,06
00210	manico cm.155	25 NR	5,96

Stadia alluminio SL2

SOLA

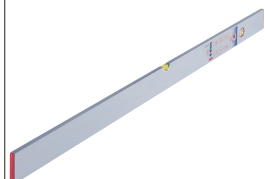

peso profilato gr/mt. 870 1 fiala orizzontale 1 fiala verticale

mt	UM	€
07164 1,5	1 NR	48,23

Stadia alluminio



sez	mt	UM	€
09554 20X80	1	5 NR	6,17
50281 20X80	1,5	5 NR	9,26
50282 20X80	2	5 NR	12,34
50283 20X80	2,5	5 NR	15,43
50284 20X80	3	5 NR	18,51
51242 20X80	3,5	5 NR	21,60
51243 20X80	4	5 NR	24,68
50291 25X100	2	5 NR	18,30
50292 25X100	2,5	5 NR	22,88
50293 25X100	3	5 NR	27,45
50294 25X100	3,5	5 NR	32,03
50295 25X100	4	5 NR	36,60

Tappo per stadie



mis	UM	€
10216 tappo 25X100	5 NR	0,58
10215 tappo 20X80	5 NR	0,58

Stadia alluminio con smusso

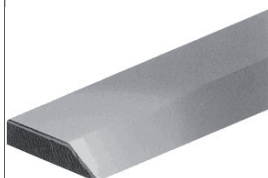

sez	mt	UM	€
09557 20X90	1,5	6 NR	13,19
09556 20X90	2	6 NR	17,59
10105 20X90	2,5	6 NR	21,98

Stadia alluminio ad "H"

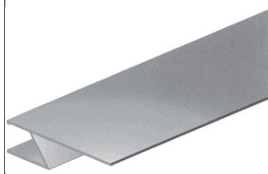

mt	UM	€
10995 1,5	6 NR	14,40
10996 2	6 NR	19,20
10997 2,5	6 NR	24,00

Stadia alluminio SLG 2

SOLA

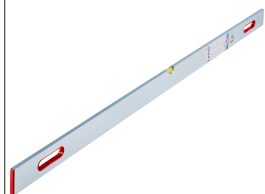

peso profilo gr/mt.870 1 fiala orizzontale 1 fiala verticale 2 impugnature in plastica

mt	UM	€
07005 2	1 NR	61,66
07006 2,5	1 NR	72,27
07007 3	1 NR	82,98

stadia alluminio SLH 3

SOLA

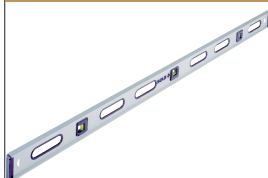

peso profilo gr/mt.1260 2 fiale verticali fiala a doppia sensibilità 6 impugnature plastica

mt	UM	€
07004 1,8	1 NR	166,50

Calandra per pareti



acciaio zincato

mt	UM	€
52795 2.00>3.20	1 NR	26,25
52796 2.80>4.30	1 NR	36,75

Chiodo fermarighe



acciaio forgiato punta piatta

UM	€
50296	100 NR 2,62

Chiodo fermarighe riaffilabile



finitura lucida punta nervata riaffilabile in acciaio trafilato e testa ricalcata

UM	€
10236	50 NR 3,21

intonacatrice lamiera manuale



rullo plastica con 14 pettini acciaio

UM	€
51573	1 NR 26,28

rullo per intonacatrice

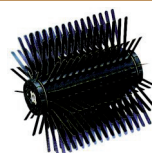

corpo in plastica con 14 pettini acciaio

UM	€
52785	1 NR 12,41

Miscelatore XO1 HF

Collomix



completo di fruste impugnatura ergonomica doppia
 • Potenza Watt 1010
 • Giri 680/min
 • Frusta WK120 HF
 • Quantità consigliata lt.40
 • Attacco HF Hexafix
 • Peso kg.5,3

UM	€
15244	1 NR 391,24

Pompa pittore a leva in ottone



con cavalletto, ad alta pressione 8 Bar. In dotazione lancia a leva ottone, filtro e tubo di aspirazione

52824 2 UM €
NR 137,90

Pompa per disarmare



serbatoio lt.6 in plastica speciale, valvola di sicurezza, lancia a leva specifica per soluzioni acide, oli, grassi, idrocarburi e carburanti

89766 6 LT UM €
NR 39,29

Smusso per pilastro

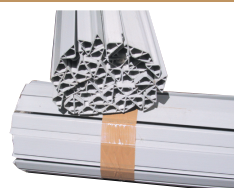

in PVC in barre da mt.2

00067 22x10 mm UM €
100 MT 0,19
00068 32x15 mm UM €
100 MT 0,29

Secchio plastica extra giallo



diam.cm.36

50178 10 UM €
NR 3,35

Secchio plastica extra rosso



diam.cm.36

50179 10 UM €
NR 3,35

Secchio plastica nero



diam.cm.34

50180 25 UM €
NR 2,18

Secchio lamiera



peso kg.2.4 (circa)

53582 10 UM €
KG 6,01

Cassoncino plastica per malta



rinforzato in ferro

50182 30 cm UM €
67x46x18 5 NR 9,08

Cassa macerie quadra



in plastica

02508 50 Pallet cm UM €
150 43x24x35 5 NR 7,89

Cassa macerie tonda



in plastica

11880 45 pallet mis UM €
120 34x48 5 NR 6,83

Contentore plastica rettangolare



04833 150 cm UM €
80x63x38 1 NR 29,59

Mastellone tondo per edilizia



07181 65 cm UM €
55x41 1 NR 12,82



Tenaglia ferraiolo 9900



in acciaio speciale temperata ad olio DIN ISO 9242

mm	cm	UM	€
50100	20	6 NR	16,90
50101	22	6 NR	17,32
50102	25	6 NR	18,95
50103	28	6 NR	20,64
50104	30	6 NR	24,67

Tenaglia ferraiolo 9910



in acciaio speciale temperato ad olio DIN ISO 9242 forma affusolata per luoghi di difficile accesso. ottima capacità di taglio

cm	UM	€
05881 30	6 NR	31,11

Tenaglia ferraiolo



acciaio cromo vanadio DIN 9242 HRC 5154

cm	UM	€
89445 22	6 NR	12,93
89446 25	6 NR	14,72
89447 28	6 NR	15,92

Tenaglia ferraiolo



acciaio forgiato

cm	UM	€
52837 22	6 NR	7,92
52838 25	6 NR	8,38

Tenaglia da ferraiolo



acciaio forgiato

cm	UM	€
83064 22	6 NR	4,67

Portatenaglia acciaio



zincocromato con passante per cintura

UM	€
50105 10 NR	1,35

Tagliabullone



coltelli neri durezza massima di taglio HRC 40

mm	ten. duro	UM	€
81650 300 mm.5 mm.4	6 NR	42,93	
81651 350 mm.7 mm.5	6 NR	47,55	
81652 450 mm.8 mm.6	6 NR	60,19	
81653 600 mm.10 mm.8	6 NR	73,58	
81654 750 mm.13 mm.9	2 NR	108,08	
81655 900 mm.16 mm.10	1 NR	144,02	

Tagliabullone



coltelli al cromo molibdeno capacità di taglio HRC 15 materiali teneri e HRC 35 materiali duri

mm	ten. duro	UM	€
81470 300 mm.5 mm.4	1 NR	17,13	
81471 350 mm.7 mm.5	1 NR	19,19	
81472 450 mm.8 mm.6	1 NR	24,22	
81473 600 mm.10 mm.8	1 NR	30,95	
81474 750 mm.13 mm.10	1 NR	43,97	

mm	UM	€
81475 900 mm.16 mm.11	1 NR	50,65

Testa per tagliabulloni

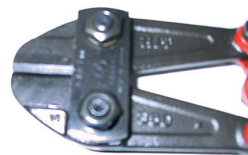

mm	UM	€
81657 350	1 NR	23,60
81658 450	1 NR	38,53
81659 600	1 NR	44,52
81660 750	1 NR	59,72
81661 900	1 NR	89,63

Testa per tagliabulloni

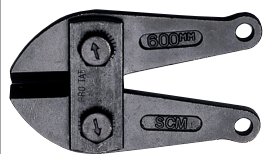

cromo molibdeno

mm	UM	€
81478 450	1 NR	15,10
81479 600	1 NR	20,20
81480 750	1 NR	27,20
81481 900	1 NR	32,75

Traccialinee ABS



con flacone di polvere blu Alta Qualità da gr.100

mt.	UM	€
00071 54594 15	12 NR	9,13

Traccialinee Alluminio



con flacone di polvere blu Alta Qualità da gr.100

mt.	UM	€
05735 54595 30	12 NR	13,51

Traccialinee Alluminio ECO



mt.	UM	€
80128 30	24 NR	5,84

Traccialinee Tracor



corpo in materiale sintetico

mt	UM	€
04377 20	6 NR	45,72

Traccialinee PRO



completo di filo mt.30 e flacone di polvere blu Alta Qualità da gr.1000

UM	€
07226 5 NR	39,23

Piombo a pera in ferro



completo di matassina filo mt.10

gr	UM	€
82637 300	6 NR	10,34
82638 400	6 NR	11,09
82639 500	6 NR	12,13

Squadra carpentiere



in acciaio tagliato al laser mm.30x6 verniciata a forno

cm	UM	€
53183 40	10 NR	7,97
50297 50	10 NR	8,61
50298 60	10 NR	9,90
50300 80	10 NR	14,14
50301 100	10 NR	17,10

Tubo per livelli



Tubo flessibile in PVC non rinforzato. Adatto al passaggio di liquidi alimentari non in pressione secondo la direttiva Europea 2007/19/EC per simulati A - B - C. in PVC trasparente

mm	mt	UM	€
05737 8X11	25	1 NR	19,88
53203 10X14	50	50 MT	0,74

Livella AV



in alluminio anodizzato color argento fiale infrangibili fiala orizzontale fluorescente con lente d'ingrandimento

- Peso profilato gr/mt. 520
- Dimensione profilato mm.50x21
- Tolleranza posizione standard mm.0.5
- Tolleranza posizione capovolta mm.1

cm	UM	€
06990 40	1 NR	21,14
06991 50	1 NR	22,92
06992 60	1 NR	24,98
06993 80	1 NR	28,78
06994 100	1 NR	33,09
06995 120	1 NR	37,40

Livella AZB



in alluminio anodizzato color argento fiale infrangibili fiala orizzontale fluorescente con lente d'ingrandimento

- Peso profilato gr/mt 590
- Dimensione profilato mm.50x23
- Tolleranza posizione standard mm.0.5
- Tolleranza posizione capovolta mm.0.75

cm	UM	€
06977 30	1 NR	24,51
06978 40	1 NR	26,60
06979 50	1 NR	28,78
06980 60	1 NR	30,97
06981 80	1 NR	35,25
06982 100	1 NR	39,71
06983 120	1 NR	43,99
06984 150	1 NR	54,29
06985 180	1 NR	63,44
07182 200	1 NR	69,59

Livella BIG X



in alluminio rosso verniciato a polvere profilo ergonomico fiala infrangibile fiala orizzontale fluorescente con lente d'ingrandimento

- Peso profilato gr/mt 630
- Dimensione profilato mm.51x25
- Tolleranza posizione standard mm.0.5
- Tolleranza posizione capovolta mm. 0.75

cm	UM	€
08733 40	1 NR	27,32
08734 50	1 NR	29,47
08735 60	1 NR	31,78
08736 80	1 NR	36,25
08737 100	1 NR	47,27
08738 120	1 NR	52,01
08739 150	1 NR	62,53
08740 180	1 NR	72,46
08741 200	1 NR	78,83

Livella AZM magnetica



in alluminio anodizzato color oro fiala infrangibile fiala orizzontale fluorescente con lente d'ingrandimento

- Peso profilato gr/mt.750
- Dimensione profilato mm.50x24
- Tolleranza posizione standard mm.0.5
- Tolleranza posizione capovolta mm.0.75

cm	UM	€
06986 30	1 NR	35,06
06987 40	1 NR	47,05
06988 50	1 NR	48,86
06989 60	1 NR	51,14

Livella AZM 3



magnetica con 3 fiale in alluminio anodizzato color oro fiale infrangibili fiala orizzontale fluorescente con lente d'ingrandimento

- Peso profilato gr/mt.750
- Dimensione profilato mm.50x24
- Tolleranza posizione standard mm.0.5
- Tolleranza posizione capovolta mm.0.75

cm	UM	€
07065 80	1 NR	72,09
07066 100	1 NR	76,55
07067 120	1 NR	91,35
07070 150	1 NR	102,84
07071 200	1 NR	120,04

Livella BIG RED 3 con impugnature



in alluminio rosso, verniciato a polvere - a montaggio termoresistente - Fiala a blocco in vetro acrilico infrangibile - Fiala orizzontale fluorescente con lente d'ingrandimento.

- Peso profilato gr/mt. 890
- Dimensione profilato mm.59x26
- Tolleranza posizione standard mm.0.3
- Tolleranza posizione capovolta mm.0.50



cm	UM	€
07161 150	1 NR	102,46
07162 180	1 NR	110,30
07163 200	1 NR	116,04

Livella CORDINAT 



in alluminio anodizzato color argento fiale infrangibili 4 calibri a corsoio regolabili scala per elettricisti paracolpi alle due estremità

- Peso profilato gr/mt. 590
- Tolleranza posizione standard mm.0.5
- Tolleranza posizione capovolta mm. 0.75

	CM		UM	€
10143	80	1	NR	27,04

Livella ENW 



alluminio anodizzato color oro inclinometro elettronico fiala orizzontale fluorescente con lente d'ingrandimento funzione HOLD dei valori rilevati segnalazione acustica su angolature dispositivo spegnimento automatico

- Peso profilato gr/mt. 890
- Dimensione profilato mm.59x26
- Tolleranza posizione standard mm.0.5
- Tolleranza posizione capovolta mm.0.5

	cm		UM	€
06997	60	1	NR	292,97

Livella ENWM magnetica 



alluminio anodizzato color oro inclinometro elettronico fiala orizzontale fluorescente con lente d'ingrandimento funzione HOLD dei valori rilevati segnalazione acustica su angolature dispositivo spegnimento automatico



- Peso profilato gr/mt. 890
- Dimensione profilato mm.59x26
- Tolleranza posizione standard mm.0.5
- Tolleranza posizione capovolta mm.0.5

	cm		UM	€
06998	60	1	NR	315,23

Livella P resina 



resina speciale fiale infrangibili fiala orizzontale fluorescente con lente d'ingrandimento resistente all'acqua al calore e al freddo tolleranza in posizione standard mm.1

	cm		UM	€
06999	40	1	NR	14,58
07000	50	1	NR	16,17
07001	60	1	NR	16,67
07002	80	1	NR	19,86

Livella UZB resina 



resina speciale base prismatica fiala infrangibile formato tascabile

	cm		UM	€
07073	8	1	NR	4,59

Livella PT 5 resina 



resina speciale 1 fiala orizzontale 1 fiala verticale 1 fiala a 45° fiale infrangibili resistente all'acqua al calore e al freddo

	cm		UM	€
07833	magnetica 20	20	NR	7,24
07832	20	20	NR	5,87

Livella JP ad angolo 





in plastica grigia 3 fiale infrangibile utilizzo in sezioni circolari e angolari dimensione cm.9x14

	07003		UM	€
		1	NR	16,08

Livella alluminio Hobby 3 bolle





base fresata e millimetrata

	cm		UM	€
83550	30	5	NR	6,91
83551	40	5	NR	7,05
83552	50	5	NR	8,09
83553	60	5	NR	9,26

Livella plastica Hobby



3 bolle base magnetica

	cm		UM	€
87133	23	1	NR	2,91

Occhiali laser LB 



Migliora la visibilità della luce laser

	07059		UM	€
		1	NR	14,49

Disto D2 



Misuratore Laser super tascabile

- Portata mt.60
- Precisione +/- 1,5 mm.
- Misurazione orizzontale automatica
- Memoria interna 10 volumi e 2 misure
- Diagonale automatica
- 2 funzioni di Pitagora



	10751		UM	€
		1	NR	198,00

Disto D210 



Misuratore Laser super tascabile

- Portata mt.80
- Precisione +/- 1 mm.
- Misurazione orizzontale automatica
- Memoria interna 10 volumi e 2 misure
- Protezione IP54
- Pitagora 2 e 3 punti
- Dimensioni mm.114x50x27

	15409		UM	€
		1	NR	244,00

Disto X310



- Misuratore Laser super tascabile
- Portata mt.80
 - Precisione +/- 1 mm.
 - Misurazione orizzontale automatica
 - Memoria interna 20 visualizzazioni
 - Protezione IP65
 - Pitagora 3 punti altezza parziale
 - Dimensioni mm.122x55x31

Leica

15410

1 UM NR € 362,00

Disto D8



- Misuratore Laser Display a colori ad alta definizione da 2,4" - BLUETOOTH
- Portata mt.100 c/laser - mt.200 c/piastra
 - Precisione +/- 1,0 mm.
 - Funzione stanza computo metro con 3 misure
 - Memoria interna 30 volumi - 60 misure
 - Diagonale automatica
 - 4 funzioni di Pitagora tracciamento guidato
 - Calcolo area triangolo - calcolo trapezio (2 mod)
 - Calcolo angolo solito (triangolo)
 - Calcolo remoto inclinazione dei tetti
 - Calcolo profilo del terreno e delle facciate

Leica

13509

1 UM NR € 839,00

Disto D3A BT



- Misuratore Laser con Tecnologia Bluetooth integrata
- Portata mt.100 c/laser
 - Precisione +/- 1 mm completo di certificato di taratura
 - Distanza orizzontale e altezza automatica
 - 4 funzioni di Pitagora
 - Diagonale automatica - tracciamento guidato doppio
 - Calcolo aree, volumi e perimetri - calcolatrice integrata
 - Display ad alta luminosità
 - Funzione stanza: computo metrico con 3 misure
 - Calcolo angolo solito (triangolo) - Funzione autoscatto
 - Memoria interna 20 volumi e 60 misure

Leica

13503

1 UM NR € 530,00

Espositore Disto Leica



MOD.
99149 METALLO
99217 CARTONE

1 UM NR €
1 NR

Leica

Prexiso X2



- misuratore laser forma ergonomica Softgrip
Funzioni area volume +/- tracciamento Pitagora
riferimento fronte retro
- Portata mt. 0.1>30
 - Precisione +/- mm.2

10468

1 UM NR € 136,00

Disto D5



- misuratore laser con display a colori da 2.4 pollici
- Portata mt.100 c/laser
 - Portata mt.200 c/piastra
 - Precisione +/- 1 mm.
 - Memoria interna 20 volumi e 60 misure
 - 4 funzioni Pitagore
 - funzione stanza c/computo metrico con 3 misure
 - Inclinometro digitale +/- 45°
 - Mirino digitale integrato (zoom x4)
 - Diagonale automatica /tracc.max

Leica

11619

1 UM NR € 538,00

Laser Lino L2



- laser a croce linee ad alta visibilità orizzontale, verticale e a croce compensatore disinseribile per pendenze e proiezioni su soffitto o pavimento autolivellamento in frazioni di secondo completo di borsa e accessori

Leica

10451

1 UM NR € 278,00

Disto D510



- Misuratore Laser - Display HD a colori da poll.2,4 - Tecnologia Bluetooth Smart 4.0
- Portata mt.200 con laser - mt.250 con piastra
 - Precisione +/- 1 mm.
 - Funzione stanza computo metrico con 3 misure
 - Memoria interna 20 volumi e 60 misure
 - Diagonale automatica
 - 4 funzioni Pitagora tracciamento guidato
 - Calcolo area a triangolo - Calcolo trapezio - Calcolo angolo solido
 - Calcolo remoto inclinazione dei tetti
 - Calcolo profilo del terreno e delle facciate
 - Mirino digitale integrato zoom 4X

Leica

16465

1 UM NR € 698,60

Laser Lino P5



- 5 punti precisi ad altissima visibilità piombo Sù-Giù-Dx-Sx-Frontale allarme fuori piombo blocco del compensatore autolivellamento in frazioni di secondo e proiezioni inclinate completo di borsa e accessori

Leica

12848

1 UM NR € 348,00

Laser Lino L2+

Leica



La vecchia e noiosa abitudine di tracciare linee sul muro, sono, oramai, un ricordo del passato. Leica Lino L2+, le proietta entrambe, perfettamente, facilmente e velocemente, permettendoti, di concentrarti solo sul lavoro, lasciandoti le mani libere. L'accresciuta ampiezza dell'angolo di proiezione delle linee, assicura una migliore visibilità e lunghezza delle linee laser e consente perfetti livellamenti ed allineamenti verticali, anche a lunghe distanze

- Ampiezza dell'angolo di 180°
- Funzione luce pulsata con modalità di risparmio batterie
- Design moderno e struttura ergonomica
- Angoli proiettati perfettamente a 90°
- Facile da utilizzare

14695

1 UM NR € 348,00

Laser Lino L2P5

Leica



laser a croce + 5 punti linee laser disposte ortogonalmente portata oltre mt. 65 con ricevitore opzionale

12847

1 UM NR € 558,00

Laser Lino L360

Leica



Il Leica Lino L360 proietta linee laser in modo preciso, rapido e tutto intorno, ampliando il raggio di lavoro a 360°. Queste caratteristiche lo rendono un valido aiuto in qualsiasi cantiere, consentendo livellamenti e allineamenti sempre perfetti.

- Linea orizzontale a 360° vicina al livello del pavimento
- Linea verticale a 180°
- Autolivellamento a pendolo smorzato
- Precisione orizzontale di 1,5 mm a 5 m
- Pacco batterie ricaricabili per una durata di esercizio prolungata
- Stagno alla polvere e protetto contro i getti d'acqua - IP65

15362

1 UM NR € 642,00

Treppiede TRI 70

Leica



In alluminio dotato di facile regolazione di precisione, piccolo e maneggevole per l'uso quotidiano e livella a bolla - Adatti per Lino e Disto

- Altezza cm.40>115
- Peso kg.1,4

15363

1 UM NR € 81,20

Treppiede TRi 100

Leica



testa robusta attacco rapido per movimenti veloci frizioni a leva borsa di trasporto adatto per linea Lino e strumenti con attacco fotografico - Adatti per Lino e Disto

- Altezza cm.70>172
- Peso kg.2,4

10523

1 UM NR € 99,40

Asta Telescopica CLR290

Leica



A scorrimento telescopico che permette il bloccaggio pavimento/soffitto dell'asta. Grazie al doppio attacco filettato, è utilizzabile con qualsiasi livella laser Particolarmente adatto a Leica LINO™ e Leica ROTEQ™

- altezza regolabile sino a 290 cm
- pressione di tenuta 45 kg
- attacco 1/4" e 5/8"

10685

1 UM NR € 114,80

Ricevitore laser

Leica



per Lino L2 e L2P5

10524

1 UM NR € 176,40

Staffa a parete

Leica



professionale per Lino

10525

1 UM NR € 74,20

Laser rotante Roteo 20 HV

Leica



laser rotante ideale per utenti che desiderano la facilità d'uso. La semplicissima tastiera è pensata per un uso intuitivo. La dotazione comprende un set completo di accessori idonei a lavori in ambiente interno, con telecomando, staffa a parete e piastra segnale.

- Laser verticale e orizzontale completamente automatico
- Staffa a parete ad altezza regolabile manualmente
- Facile accesso alla testa del laser
- Piombo a raggio 90
- Eccezionale durata della batteria

14180

1 UM NR € 860,00

Laser rotante Roteo 35 WMR

Leica



rotante automatico per Piani orizzontali e verticali Squadri Scansioni Doppie pendenze manuali e allarme Quota completo di staffa motorizzata millimetrata custodia antiurto adatt.batterie alcaline (160 ore) caricatore universale occhiali rossi e targhet magnetico

- Campo d'azione mt.300 con ricevitore (compreso)
- Precisione +/- mm.3 a mt.30

10825

UM €
0 NR 1442,00

Livello Rotante Roteo 35G

Leica



rotante automatico a raggio VERDE per piani orizzontali e verticali, squadri, scansioni, doppie pendenze manuali e allarme di quota. Completo di staffa motorizzata millimetrata integrata custodia antiurto e adatt.batteria alcaline (30 ore) caricatore universale, occhiali verdi e targhet magnetico.

- Campo d'azione mt.300 con ricevitore (compreso)
- Precisione +/- mm.3 a mt.30

12893

UM €
1 NR 1729,00

Ricevitore RRC350

Leica



con telecomando integrato per Roteo

- Individua il piano laser proiettato, in caso di lunghe distanze, o in presenza di forte luce solare
- Intercepta il piano laser proiettato, fino a 150m
- Ricevitore con telecomando integrato, con tutte le principali funzioni (portata: 30m/100ft)
- Un segnale audio (beep) e visivo, permette l'individuazione del piano proiettato, senza errori
- Fornito con morsetto di fissaggio, per aumentarne la versatilità in molte applicazioni
- Disegno ergonomico, con doppio display LCD, fronte/retro

12968

UM €
1 NR 287,00

Ricevitore R250

Leica



per Roteo 20HV

- Individua il piano laser proiettato, in caso di lunghe distanze, o in presenza di forte luce solare
- Intercepta il piano laser proiettato, fino a 150m
- Un segnale audio (beep) e visivo, permette l'individuazione del piano proiettato, senza errori
- Fornito con morsetto di fissaggio, per aumentarne la versatilità in molte applicazioni
- Disegno ergonomico, con doppio display LCD, fronte/retro

13551

UM €
1 NR 214,20

Supporto universale per livelli laser

SOLA



sistema multiuso di montaggio composto da due parti: la staffa a "L" in ABS rinforzato con fibre di vetro dotata di tutte le regolazioni principali e il morsetto posteriore sgangiabile che permette il fissaggio su una grande varietà di oggetti e materiali.

15598

UM €
1 NR 176,55

Stadia CLR250

Leica



in alluminio mt.2,5 per Roteo

10658 2,5

UM €
1 NR 114,80

Stadia telescopica GSS 111

Leica



in alluminio a doppia gradazione mt.5 a 4 sezioni codice a barra /scala ad E con gradazione in cm custodia di trasporto

09603

UM €
1 NR 134,40

Stadia telescopica BTL 4D

Leica



in alluminio mt. 5. Graduata in cm. Retro graduato in mm. con bolla sferica e custodia. Linea per Jogger

10660

UM €
1 NR 123,20

Treppiede

Leica



in alluminio Professionale

10646 74-122
10657 94-142

UM €
1 NR 159,60
1 NR 201,60

Mod. JOGGER 24

Leica



LIVELLO AUTOMATICO

Deviazione standard per 1 km Livellamento doppio : ± 2.0 mm
Cannocchiale Immagine verticale
Ingrandimento 24X Diam. libero obiettivo 36mm
Distanza minima di messa a fuoco <1.0 m
Campo di visuale a 100 m < 2.1m
Costante di moltiplicazione 100
Costante d'addizione 0 Compensatore
Campo di lavoro $\pm 15'$
Precisione di centramento (dev. std.) <0.5"
Livella sferica 8/2 mm Cerchio azimutale
Graduazione 360 Gradi Intervallo 1°
Peso (netto) 1.5 kg Limiti di temperatura di misura da -20°C a +40°C

	UM	€
10659	1 NR	358,00

Palina

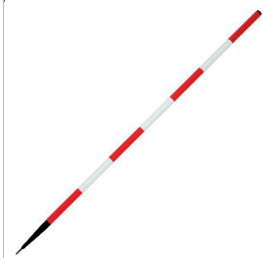

in legno esagonale diam.mm.28 con puntale in ferro corpo verniciato rosso e bianco ogni cm.20 altezza totale cm. 160

	UM	€
50338	12 NR	14,15

Doppiometro poliammide HK 2/10

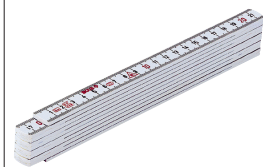

rinforzato con fibra di vetro Colore bianco Lunghezza mt.2 con 10 stecche Scala graduata in mm sui due lati Resistente al freddo grazie alla fibra di vetro

	UM	€
07017	10 NR	9,30

Doppiometro legno HF 2/10

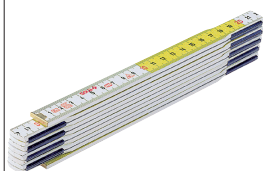

in legno di faggio selezionato di colore bianco e giallo Lunghezza mt.2 a 10 stecche Scala graduata in mm sui due lati Verniciatura di protezione con indurimento da irraggiamento UV Cerniere nascoste in acciaio svedese alta qualità con protezione anticorrosione

	UM	€
07016	10 NR	5,93

Doppiometro legno H 2/10



in legno di betulla del nord Colore naturale Lunghezza mt.2 a 10 stecche Scala graduata in mm sui due lati Verniciatura di protezione con indurimento da irraggiamento UV Cerniere nascoste con protezione anticorrosione

	UM	€
07015	10 NR	9,55

Doppiometro legno 617



in legno selezionato Colore bianco e giallo Lunghezza mt.2 con 10 stecche Molle in acciaio anticorrosione

	UM	€
50342	10 NR	6,99

Doppiometro legno acero



	UM	€
50341	5 NR	2,31

Doppiometro legno giallo



	UM	€
50340	10 NR	1,82

Flessometro BIG T

SOLA



cassa infrangibile ergonomica Ammortizzatore di riavvolgimento Nastro acciaio giallo antiriflesso Classe di precisione 1

	mt/mm	UM	€
08193	5/19	5 NR	31,19
08194	8/25	5 NR	44,58

Flessometro TRI-MATIC

SOLA



cassa in plastica cromata Ammortizzatore di riavvolgimento Nastro acciaio giallo antiriflesso Classe di precisione 1

	mt/mm	UM	€
07018	3/13	6 NR	16,17
07019	5/19	6 NR	28,00
07020	8/25	6 NR	42,90
07021	10/25	6 NR	50,55

Flessometro POPULAR

SOLA



cassa ergonomica antiscivolo Ammortizzatore di riavvolgimento Nastro acciaio giallo antiriflesso

	mt/mm	UM	€
10273	3/13	10 NR	7,46
10274	5/19	6 NR	14,55
10275	8/25	6 NR	23,63

Flessometro STRIP



cassa in gomma e ABS

Art.	mt/mm	UM	€
91874	3/19	1 NR	4,10
91875	5/25	12 NR	6,42
91876	8/25	12 NR	8,25

Flessometro WHOLLY



cassa in gomma antiscivolo Nastro autobloccante

Art.	mt/mm	UM	€
93041	3/16	12 NR	4,85
93042	5/25	12 NR	7,50
93043	8/25	12 NR	9,93

Flessometro GAUGER



cassa in materiale bicomponente antiscivolo Nastro in acciaio con calamita

Art.	mt/mm	UM	€
91877	3/19	12 NR	6,63
91878	5/25	12 NR	9,39
91879	8/25	12 NR	12,08
91880	10/25	12 NR	15,02

Flessometro PLATINUM



cassa in materiale bicomponente antiscivolo Nastro in acciaio con calamita

Art.	mt/mm	UM	€
91882	5/25	12 NR	11,88
91883	8/25	12 NR	15,32

Rotella metrica PROSPECTOR C



nastro acciaio giallo rivestito in Tufcote resistente alla flessione Scala graduata in mm Telaio Y in alluminio Gancio multifunzionale

Art.	mt/mm	UM	€
07024	50/13	1 NR	148,33

Rotella metrica SATELLITE



nastro acciaio bianco Scala graduata in mm Cassa in plastica di elevata solidità ergonomica Gancio multifunzionale

Art.	mt/mm	UM	€
07023	20/10	1 NR	34,94

Rotella metrica FUTURA



nastro in fibra di vetro giallo Scala graduata in cm. Cassa in plastica di elevata solidità ergonomica Gancio terminale in plastica Manovella integrata

Art.	mt/mm	UM	€
07022	20/13	1 NR	43,58

Rotella metrica SURVEYOR



nastro in acciaio verniciato rivestito in Tufcote da 13 mm. di larghezza così da renderlo scorrevole e duraturo, impugnatura ergonomica e funzionale, maniglie laterali per facile riavvolgimento e pulsante di blocco nastro

Art.	mt.	UM	€
15594	30	1 NR	131,09
15595	50	1 NR	167,93

Rotella metrica EXPERT



cassa plastica Nastro in fibra di vetro

Art.	mt/mm	UM	€
84505	20/13	1 NR	8,03

Rotella metrica PROJET



cassa materiale bicomponente Nastro acciaio smaltato Sistema riavvolgimento nastro 3X ad alta velocità

Art.	mt/mm	UM	€
91884	20/9.5	1 NR	14,93

Rotella metrica SURVEY



cassa a croce in materiale plastico Nastro acciaio smaltato

Art.	mt/mm	UM	€
84506	50/10	1 NR	33,36

Rotella metrica 3X HIGH SPEED



cassa in materiale plastico Nastro acciaio smaltato Riavvolgimento alta velocità 3X

Art.	mt/mm	UM	€
89817	50/10	1 NR	68,36

Rotella metrica 3X HIGH SPEED



cassa in materiale plastico Nastro fibra di vetro Riavvolgimento alta velocità 3X

Art.	mt.	UM	€
89818	50/13	1 NR	26,00

Squadra falegname



mm	UM	€
83478 200	12 NR	2,97
83480 250	12 NR	3,23
80903 300	12 NR	3,20

Matita ZB



per falegnami e carpentieri in legno di tiglio laccata rossa Mina in grafite HB

cm	UM	€
09380 18	100 NR	0,96
09381 24	100 NR	1,21

Matita RBB



per idraulici, posatori cartongesso in legni di tiglio laccata rosso/blu. Mina in grafite addizionata con cera

cm	UM	€
16767 17	100 NR	1,40

Matita STB



per muratori, professionisti nel settore costruzioni, piastrellisti, addetti alla costruzione di casseforme in legno di tiglio laccata verde. Mina stabile in grafite dura 10H

cm	UM	€
16768 24	100 NR	1,29

Matita UB



per muratori, professionisti nel settore costruzioni, piastrellisti, addetti alla costruzione di casseforme in legno di tiglio, Mina in grafite con parti in cera. Scrive su ogni supporto

cm	UM	€
16769 24	75 NR	2,06

Matita falegname



cm	UM	€
86236 18	100 NR	0,26
86237 24	144 NR	0,38

Matita scalpellino



cm	UM	€
09382 30	100 NR	1,62

Gesso



esagonale adatto a quasi tutte le superfici

mm	colore	UM	€
04530 95	rosso	1 DZ	14,42
04531 95	giallo	1 DZ	14,42

Pennarello indelebile

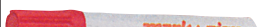

marcatura permanente Punta tonda



colore	UM	€
04529 rosso	12 NR	2,01
12407 nero	12 NR	2,01

Calibro a corsoio 1/20



acciaio cromato

mm	UM	€
89567 150	10 NR	13,17
89568 200	10 NR	21,11

Calibro a corsoio plastica



mm	UM	€
80899 150	1 NR	2,09

Calibro a corsoio elettronico



In acciaio inox temperato - Lettura 1/100 (0,01 mm.) - Display LCD a 5 cifre - Pulsante selezione mm./pollici - Batteria da 1,5 Volt LR44 (inclusa) - Becchi 40 mm. - Lunghezza mm.240 - Apertura max mm.150

UM	€
93110 1 NR	20,94

Mascherina protezione



leggera in fibra sintetica pressata con stringinaso

PZ	UM	€
81078 10	100 BL	2,05
80196 50	20 CF	7,12

Mascherina Pieghevole FFP2



Data la particolare forma, offrono minor resistenza alla respirazione e quindi un comfort maggiore - La clip di plastica permette un adattamento al naso-faccia molto comodo grazie anche al rivestimento di gommapiuma interno al nasello - Forniscono un livello di protezione con valvola - Facile da portare in tasca e comodo da indossare - Norme CE 0086 EN 149:2001+A1:2009

Cf	Cl	UM	€
92751 10	FFP1 C/Valvola	10 NR	1,18
92752 10	FFP2 C/Valvola	10 NR	1,34

Mascherina FFP1



Protezione contro aerosol solidi e liquidi (es. polveri) non tossici in concentrazione fino a 4,5xTLV - Utilizzo: abrasione di vernice e ruggine. Lavori edili con gesso, marmo, cemento. Sanificazione ambientale. Lavorazione granaglie - Modello con stringinaso - Norme CE 0086 EN 149:2001+A1:2009

Cf	CL	UM	€
88573 5	FFP1 S/Valvola	10 BL	5,37
87200 20	FFP1 S/Valvola	20 PZ	0,88
88574 3	FFP1 C/Valvola	12 BL	4,63
87201 10	FFP1 C/Valvola	10 PZ	1,25
88575 3	FFP1 Carboni	10 BL	5,82
87202 20	FFP1 Carboni	20 PZ	1,20
88576 3	FFP1 Carb/Valv	10 BL	5,49
87203 10	FFP1 Carb/Valv	10 PZ	1,49

Mascherina FFP2



Protezione contro aerosol solidi e liquidi (es. polveri) di bassa e media nocività in concentrazione fino 12xTLV (es. alluminio, silice, carbone) - Utilizzo: carteggiatura su legno, vernici, stucchi e metalli leggeri. Lubrificazione macchinari, saldature, nebulizzazione oli e silicone. Fonderie. Distillazione solventi. Verniciatura a spruzzo. Nebulizzazione di pesticidi - Modello con stringinaso - Norme CE 0086 EN 149:2001+A1:2009

Cf	Cl	UM	€
87204	20 FFP2 S/Valvola	20 PZ	1,01
87205	10 FFP2 C/Valvola	10 PZ	1,33

Mascherina FFP3



Protezione contro aerosol solidi e liquidi (es. nebbie oleose e a base acquosa) di bassa/media tossicità e altamente tossici in concentrazione fino a 50xTLV o 20xAPP - Utilizzi: lavorazioni su metalli pesanti con cromo, nichel e piombo. Smaltimento amianto e rifiuti tossici. Impiego di fibre di vetro. Industrie farmaceutiche e petrolchimiche - Norme CE 0086 EN 149:2001+A1:2009

Cf	CL	UM	€
89730	5 FFP3 C/Valvola	5 PZ	3,72

Mascherina Rigida FFP1



Dispositivi facciali antipolvere con stringinaso - Protezione contro polveri e aerosol non tossici in concentrazione fino 4,5 per TLV - Le maschere hanno superato i test di resistenza all'intasamento con polvere Dolomite (D) - Struttura in plastica rigida con valvola - Norme EN 149:2001+A1:2009

Cf	CL	UM	€
93738	5 FFP1 C/Valvola	1 CF	12,76

Mascherina Rigida FFP2



Dispositivi facciali antipolvere con stringinaso - Protezione contro polveri e aerosol di bassa e media nocività in concentrazione fino 12 per TLV - Le maschere hanno superato i test di resistenza all'intasamento con polvere Dolomite (D) - Struttura in plastica rigida con valvola - Norme EN 149:2001+A1:2009

Cf	CL	UM	€
93739	5 FFP2 C/Valvola	1 CF	14,00

Mascherina 3M FFP1



monouso contro polveri, fumi e nebbie Classe FFP1

mod	UM	€
04430 8710 S/Valvola	20 PZ	1,48
04432 8812 C/Valvola	10 PZ	3,00
04434 9913 carboni	20 PZ	6,13

Mascherina 3M FFP2



monouso contro polveri, fumi e nebbie Classe FFP2

mod	UM	€
04431 8810 S/Valvola	20 PZ	3,94
04433 8822 C/Valvola	10 PZ	5,60

Mascherina 3M Pieghevole



monouso contro polveri, fumi e nebbie

mod	Cl	UM	€
05781 9312 FFP1C/Valvola	10 PZ	4,08	
05782 9320 FFP2S/Valvola	20 PZ	3,94	
05783 9322 FFP2C/Valvola	10 PZ	5,60	

Mascherina 3M Mod.9925



monouso per saldatura classe FFP2

UM	€
04435 10 PZ	13,57

Mascherina 3M Mod.8835



monouso con valvola Classe FFP3

UM	€
05659 5 PZ	15,26

Mascherina 3M Mod.4251



con filtri incorporati Classe FFA1P1 efficace per polveri, vapori organici, insetticidi impiegate nella verniciatura a spruzzo

UM	€
04429 1 PZ	41,12

Tris protezione



composto da occhiali, cuffia e mascherine

UM	€
89152 1 NR	8,66

Casco muratore



in Polietene HD con fascia antisudore UNI EN397

colore	UM	€
93769 giallo	1 NR	4,74
06891 bianco	1 NR	4,74

Casco muratore



Bardatura tessile 8 punti - Canale per la pioggia
- Attacchi universali per cuffie - Ventilato -
Regolabile a norme EN397 - con sottogola a
mentoniera

	UM	€
93768 con rotella	1 NR	18,46
93769 giallo	1 NR	4,74

Sottogola



con mentoniera per casco protezione

	UM	€
10605 normale	10 NR	2,18

Occhiali panoramici



con fori di areazione EN166 3 4 9B

	UM	€
80195	24 NR	3,65

Occhiali a mascherina



lenti neutre con elastico

	UM	€
93142	12 NR	7,04

Occhiali protezione



trasparenti con stanghette fisse 1F EN166

	UM	€
87360	12 NR	5,83

Occhiali protezione



trasparenti con stanghette allungabili 1F EN166

	UM	€
88339 trasparenti	12 NR	6,95

Occhiali protezione



Occhiali di protezione avvolgenti - Lenti in
policarbonato antigraffio e con protezione UV
- Astine e nasello in morbida gomma per un
maggiore comfort - A norme EN 166 0530

	UM	€
93143	12 NR	6,75

Occhiali protezione con luci



avvolgenti con luci Led orientabili super luminosi
- Da 4700÷5300 mlm. - Ogni Led funziona con
2 batterie al litio CR 2032 3V (incluse) - Lenti
in policarbonato antigraffio e con protezione
UV - Astine e nasello in morbida gomma per un
maggior comfort - A norme CE EN 166 0530

	UM	€
94095	1 NR	13,99

Tappi auricolari



Monouso ad espansione - In schiuma
poliuretana morbida, ipoallergenica - Forma
conica, si adattano a qualsiasi tipo di condotto
uditivo - Confezionati in sacchetti di plastica da
2 tappi - Abbattimento acustico SNR 37 DB -
Norme CE EN 352:2002
Confezione pz.200 paia

	UM	€
94093	1 CF	42,95

Tappi auricolari con cordino



Monouso ad espansione con cordino - In
schiuma poliuretana morbida, ipoallergenica
- Forma conica, si adattano a qualsiasi tipo di
condotto uditivo - Confezionati in sacchetti di
plastica da 2 tappi - Abbattimento acustico SNR
37 DB - Norme CE EN 352:2002
Confezione pz.50 paia

	UM	€
94094	1 CF	22,90

Tappi auricolari 1100

3M



a norme EN352-2

	UM	€
04424	200 PA	0,30

Tappi auricolari 1310

3M



con archetto a norma EN352-2

	UM	€
04425	10 NR	8,82
04426 ricambi	10 NR	2,81

Cuffia H510A

3M



La cuffia H510 A è la scelta ideale per lavori
brevi o lunghi. Gli auricolari ampi e comodi,
imbottiti con una combinazione esclusiva di
liquido e schiuma, offrono tenuta ottimale e
pressione ridotta.

	UM	€
04427	1 NR	27,99

Cuffia Maurer



antirumore ad archetto

80923

10 UM NR € 11,29

Ginocchiere piastrellista



in poliuretano, morbide e leggere per la massima comodità e protezione - Massima tenuta sulle superfici lisce - Taglia unica con cinghie regolabili - Confezione in busta - Norme EN 14404:2004

93056

1 UM PA € 13,47

Cuffia Maurer



antirumore Professionale ad archetto imbottito

94005

1 UM NR € 12,28

Ginocchiere piastrellista



Ginocchiere con imbottitura interna in gel e fascia di chiusura regolabile con il velcro, per la massima protezione del ginocchio e la massima comodità - Progettate specialmente per i professionisti che trascorrono lunghi periodi di lavoro inginocchiati - Confezione in scatola - Norme EN 14404:2004

93055

1 UM PA € 22,38

Cassetta soccorso A-B



pronto soccorso per 3 unità e oltre. Dimensione cm.41x31x10

08917

1 UM NR € 80,09

Ciabatte piastrellista



con molla piano zigrinato

04324

48 UM PA € 7,80

Cassetta soccorso C



pronto soccorso per meno di 3 unità. Dimensione cm.32x23x9

08918

1 UM NR € 22,54

Cintura di posizionamento



con schienale termoformato - 2 Punti di ancoraggio EN358

53698

1 UM NR € 32,18

Ginocchiere a soffietto



per piastrellista professionali in poliuretano espanso con elastici in para

06688

20 UM PA € 16,64

Imbracatura anticaduta



con attacchi dorsale e sternale, fascia sottoglutei, cosciali regolabili EN361

93847

1 UM NR € 35,15

Ginocchiere lunghe

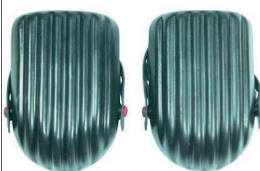

per piastrellista in poliuretano espanso con elastici in para

06457
06035 elastico ric.

25 UM PA € 10,23
1 UM NR € 1,34

Imbracatura anticaduta



con attacchi dorsale e sternale, fascia sottoglutei, prolunga dorsale, cosciali e bretelle regolabili EN361

93848

1 UM NR € 46,33

Cintura con Imbracatura anticaduta



Cintura di posizionamento con schienale termoformato completa di imbracatura con attacchi dorsale e sternale, fascia sottogluetei, prolunga dorsale, cosciali e bretelle regolabili EN358 - EN361

93849 1 UM € 88,48
NR

Cordino di posizionamento

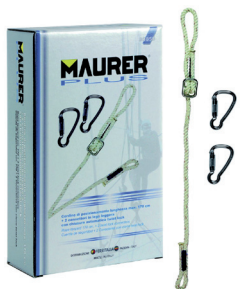

lunghezza cm.170, con regolatore di lunghezza in lega leggera e 2 connettori in lega leggera con chiusura automatica Twist Lock EN358

93850 1 UM € 60,16
NR

Assorbitore di Energia

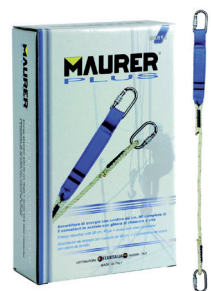

con cordino da cm.90 con due connettori ovali in acciaio con ghiera di chiusura a vite lunghezza totale cm.140 EN355

93851 1 UM € 43,52
NR

Assorbitore di Energia



con cordino a "Y" da cm.70 con 1 connettore ovale in acciaio con ghiera di chiusura a vite e 2 connettori in lega leggera chiusura doppia leva apertura mm.60, lunghezza totale cm.135 EN355

93852 1 UM € 82,39
NR

Connettore Ovale in acciaio



con ghiera di chiusura a vite EN362

93853 5 UM € 10,60
NR

Connettore in Lega leggera



con chiusura automatica Twist Lock EN362

93854 5 UM € 27,74
NR

Connettore



doppia leva apertura mm.53

17484 1 UM € 21,27
NR

Dispositivo Anticaduta



retrattile con connettore ovale in acciaio con ghiera di chiusura a vite, carter sintetico, cavo acciaio diam.mm.4 lunghezza mt.10 con connettore in lega leggera con ghiera di chiusura a vite. In valigetta EN360

93856 1 UM € 508,64
NR

Casco ponteggi



Certificato EN397 - il sottogola è progettato per aprirsi in caso di urto
 • Calotta esterna in ABS
 • Calotta interna in Polistirene espando ad alta densità
 • Girotesta interno con sistema di regolazione taglia
 • Ventilazione a 6 fori - Clips fermalampada
 • Sistema di sgancio di sicurezza
 • Sistema fermalampada - Fibbia a sgancio rapido
 • Sottogola regolabile
 • Peso gr.385

94199 1 UM € 43,46
NR

Tuta usa e getta



monouso in polipropilene tessuto non tessuto, impermeabile all'acqua e all'aria, trattamento antistatico

	TG	UM	€
88513	L	50 NR	2,93
88514	XL	50 NR	2,93
88515	XXL	50 NR	2,93

Completo impermeabile



Giacca e pantaloni in poliestere-PVC - Con cappuccio a scomparsa - Confezione in busta singola richiudibile

	tg	col	UM	€
91486	M	verde	1 NR	14,15
91487	L	verde	1 NR	16,28
91488	XL	verde	1 NR	16,28
91489	XXL	verde	1 NR	16,28
91490	M	giallo	1 NR	13,80
91491	L	giallo	1 NR	15,98
91492	XL	giallo	1 NR	15,98

mis	col	UM	€
91493 XXL	giallo	1 NR	15,98
92173 L	blu	1 NR	14,77
92174 XL	blu	1 NR	14,77
92175 XXL	blu	1 NR	14,77

Impermeabile



con cappuccio in PVC giallo

Tg	UM	€
83327 L	25 NR	11,27
83328 XL	25 NR	11,27
83989 XXL	25 NR	11,27

Scarpa Postumia



Protezione S1P

- Tomaia in crosta scamosciata Col.Visone inserti in tessuto SPINNAKER
- Fodera Aerpluss ZH 320 gr/mq col.beige con feltro nella zona punta
- Suola in poliuretano bidensità Col.Nero - Grigio coprente con spunterbo
- Suoletta "Schiumato" col.Nero, antiscatico, assorbente, antibatterico ai carboni attivi
- Puntale in acciaio resistente a 200 joule EN12568
- Lamina Antiperforazione in acciaio EN12568
- Peso gr.650 ca

mis	UM	€
92730 38	5 NR	59,61
10630 39	5 NR	59,61
10631 40	10 NR	59,61
10632 41	10 NR	59,61
10633 42	10 NR	59,61
10634 43	10 NR	59,61
10635 44	10 NR	59,61
10636 45	10 NR	59,61
10637 46	5 NR	59,61

Scarpa Flaminia



Protezione S1P

- Tomaia in crosta scamosciata Col.Visone inserti in tessuto SPINNAKER
- Fodera Aerpluss ZH 320 gr/mq col.beige con feltro nella zona punta
- Suola in poliuretano bidensità Col.Nero - Grigio coprente con spunterbo
- Suoletta "Schiumato" col.Nero, antiscatico, assorbente, antibatterico ai carboni attivi
- Puntale in acciaio resistente a 200 joule EN12568
- Lamina Antiperforazione in acciaio EN12568
- Peso gr.665 ca

mis	UM	€
10638 39	5 NR	64,24
10639 40	10 NR	64,24
10640 41	10 NR	64,24
10641 42	10 NR	64,24
10642 43	10 NR	64,24
10643 44	10 NR	64,24
10644 45	10 NR	64,24
10645 46	5 NR	64,24

Scarpa Aurelia



Protezione S1P

- Tomaia in crosta scamosciata bottolata Col.Taupe inserti in tessuto TEX supertraspirante
- Suola in poliuretano bidensità Col.Nero - Para trasparente

mis	UM	€
92041 38	5 NR	86,44
92042 39	5 NR	86,44
92043 40	10 NR	86,44
92044 41	10 NR	86,44
92045 42	10 NR	86,44
92046 43	10 NR	86,44
92047 44	10 NR	86,44
92048 45	10 NR	86,44
92049 46	5 NR	86,44

Scarpa Cassia



Protezione S3

- Tomaia in pelle Nabuk ingrassato idrorepellente Col. Marrone - Nero
- Fodera Aerpluss BZB 320 gr/mq assorbente con inserto tallone in microfibra
- Suola in poliuretano bidensità Col.Nero - Para trasparente con spunterbo
- Suoletta "Blowfit" anatomico in Fusstatic, antiscatico, assorbente, antibatterico ai carboni attivi
- Puntale in materiale composito resistente a 200 joule EN12568
- Lamina Antiperforazione in acciaio EN12568
- Peso gr.660 ca

mis	UM	€
91830 39	5 NR	99,54
91831 40	10 NR	99,54
91832 41	10 NR	99,54
91833 42	10 NR	99,54
91834 43	10 NR	99,54
91835 44	10 NR	99,54
91836 45	10 NR	99,54
91837 46	5 NR	99,54

Scarpa Salaria



Protezione S3

- Tomaia in pelle colore Marrone
- Tallone shock absorber
- Suola (antistatic - oil resistant)
- Puntale composito
- Lamina antiperforazione Kevlar tessuto alta tenacità (HT)

mis	UM	€
94211 39	1 NR	55,75
94212 40	1 NR	55,75
94213 41	1 NR	55,75
94214 42	1 NR	55,75
94215 43	1 NR	55,75
94216 44	1 NR	55,75
94217 45	1 NR	55,75
94218 46	1 NR	55,75

Scarpa Tinto



Protezione S1P

- Tomaia Pelle scamosciata inserti rete nylon traspirante
- Fodera Wind System 3D
- Suola PU compatto
- Suoletta soffice PU espanso
- Puntale e lamina composita

mis	UM	€
17278 39	1 NR	77,13
17279 40	1 NR	77,13

mis	UM	€
17280 41	1 NR	77,13
17281 42	1 NR	77,13
17282 43	1 NR	77,13
17283 44	1 NR	77,13
17284 45	1 NR	77,13
17285 46	1 NR	77,13

Scarpa Unique



- Protezione S1P**
- Tomaia Pelle scamosciata forata marrone
 - Fodera Wind System 3D
 - Suola PU compatto
 - Suoletta soffice PU espanso
 - Puntale e lamina in acciaio

mis	UM	€
17270 39	1 NR	44,16
17271 40	1 NR	44,16
17272 41	1 NR	44,16
17273 42	1 NR	44,16
17274 43	1 NR	44,16
17275 44	1 NR	44,16
17276 45	1 NR	44,16
17277 46	1 NR	44,16

Scarpa Base donna



- Protezione S1P SRC**
- Tomaia in pelle scamosciata
 - Tessuto 3D Hi - Tech
 - Plantare estraibile Dry'n air gel
 - Sottopiede Fresh'n Flex
 - Puntale in acciaio

mis	UM	€
14078 35	1 NR	80,71
14079 36	1 NR	80,71
14080 37	1 NR	80,71
14081 38	1 NR	80,71
14082 39	1 NR	80,71
14083 40	1 NR	80,71

Scarpa Blues 91186.01



- Protezione S1P**
- Tomaia: scamosciato Millefori bottalato + sc bottalato
 - Fodera: Aired 3D 320 gr. + DualMicro
 - Suola: PU Dual-Density SRC passed
 - Suoletta: Soft-fit
 - Puntale: ALU-SXT Aluminium
 - Antiperforazione: L-Protection PS 0 - STADT

mis	UM	€
13233 39	5 NR	94,03
13234 40	5 NR	94,03
13235 41	5 NR	94,03
13236 42	5 NR	94,03
13237 43	5 NR	94,03
13238 44	5 NR	94,03
13239 45	5 NR	94,03
13240 46	5 NR	94,03

Scarpa Blues 91186.02



- Protezione S1P**
- Tomaia: crosta scamosciata + AIRFIT HT
 - Fodera: Aired 3D 320 gr. + DualMicro
 - Suola: PU Dual-Density SRC passed
 - Suoletta: Soft-fit
 - Puntale: ALU-SXT Aluminium
 - Antiperforazione: L-Protection PS 0 - STADT

mis	UM	€
13241 39	5 NR	93,94
13242 40	5 NR	93,94
13243 41	5 NR	93,94
13244 42	5 NR	93,94
13245 43	5 NR	93,94

mis	UM	€
13246 44	5 NR	93,94
13247 45	5 NR	93,94
13248 46	5 NR	93,94

Scarpa Dance 91195.03



- Protezione S1P**
- Tomaia: scamosciato Millefori bottalato + sc bottalato
 - Fodera: Aired 3D 320 gr. + DualMicro
 - Suola: PU Dual-Density SRC passed
 - Suoletta: Soft-fit
 - Puntale: ALU-SXT Aluminium
 - Antiperforazione: L-Protection PS 0 - STADT

mis	UM	€
13265 35	5 NR	92,67
13266 36	5 NR	92,67
13267 37	5 NR	92,67
13268 38	5 NR	92,67
13257 39	5 NR	92,67
13258 40	5 NR	92,67
13259 41	5 NR	92,67
13260 42	5 NR	92,67
13261 43	5 NR	92,67
13262 44	5 NR	92,67
13263 45	5 NR	92,67
13264 46	5 NR	92,67

Scarpa Dance 92195.00



- Protezione S3**
- Tomaia: pelle pieno fiore stampato Hydrotech
 - Fodera: Aired 3D 320 gr. + DualMicro
 - Suola: PU / TPU / SRC passed
 - Suoletta: Pulse
 - Puntale: ALU-SXT Aluminium
 - Antiperforazione: L-Protection PS 0 - STADT

mis	UM	€
13249 39	5 NR	105,44
13250 40	5 NR	105,44
13251 41	5 NR	105,44
13252 42	5 NR	105,44
13253 43	5 NR	105,44
13254 44	5 NR	105,44
13255 45	5 NR	105,44
13256 46	5 NR	105,44

Scarpa Sierra



- Protezione S3**
- Tomaia: nubuc ingrassato + tessuto trattato Teflon
 - Fodera Aired 3D 320 gr. + DualMicro
 - Suoletta: Blowfit
 - Suola: PU Dual-Density / SRC passed
 - Puntale: C.T.C. Composite Toe Cap
 - Antiperforazione: L-Protection PSW4(K) 1400 N

mis.	UM	€
15150 39	5 NR	103,74
15151 40	10 NR	103,74
15152 41	10 NR	103,74
15153 42	10 NR	103,74
15154 43	10 NR	103,74
15155 44	10 NR	103,74
15156 45	10 NR	103,74
15157 46	5 NR	103,74

Scarpa Steppa



- Protezione S3**
- Tomaia in pelle Nubuk ingrassata
 - Fodera Aired 3D 320 gr. + DualMicro
 - Suoletta: Blowfit
 - Suola: PU Dual-Density / SRC passed
 - Puntale: C.T.C. Composite Toe Cap
 - Antiperforazione: L-Protection PSW4(K) 1400 N

mis	UM	€
15142 39	5 NR	112,91

mis	UM	€
15143 40	1 NR	112,91
15144 41	10 NR	112,91
15145 42	10 NR	112,91
15146 43	10 NR	112,91
15147 44	10 NR	112,91
15148 45	10 NR	112,91
15149 46	5 NR	112,91

Scarpa Dance 91195-24L



- Protezione S3**
- Tomaia in Pieno Fiore Martin
 - Fodera Pieno Fiore concia WET WHITE
 - Suola PU Dual Density SRC Passed
 - Suoletta SoftFit anatomico
 - Puntale ALU-SXT Aluminium
 - Lamina Antiperforazione Q Zero Flex EN 12568:2010
 - Peso gr.542 ca

mis	UM	€
16394 39	1 NR	115,12
16395 40	1 NR	115,12
16396 41	1 NR	115,12
16397 42	1 NR	115,12
16398 43	1 NR	115,12
16399 44	1 NR	115,12
16400 45	1 NR	115,12
16401 46	1 NR	115,12

Scarpa Pasitos 91253-04L



- Protezione S1P**
- Tomaia in Nubuk Hydrotech + Scamosciato bott Hydro
 - Fodera Aired 3D 320 gr + DualMicro
 - Suola PU Dual Density SRC Passed
 - Suoletta SoftFit anatomico
 - Puntale ALU-SXT Aluminium
 - Lamina Antiperforazione Q Zero Flex 4 EN
 - 12568:2010
 - Peso gr.541 ca

mis	UM	€
16402 39	1 NR	109,85
16403 40	1 NR	109,85
16404 41	1 NR	109,85
16405 42	1 NR	109,85
16406 43	1 NR	109,85
16407 44	1 NR	109,85
16408 45	1 NR	109,85
16409 46	1 NR	109,85

Scarpa Pasitos 91253-01L



- Protezione S1P**
- Tomaia in Nubuk Hydrotech + Scamosciato bott Hydro
 - Fodera Aired 3D 320 gr + DualMicro
 - Suola PU Dual Density SRC Passed
 - Suoletta SoftFit anatomico
 - Puntale ALU-SXT Aluminium
 - Lamina Antiperforazione Q Zero Flex 4 EN
 - 12568:2010
 - Peso gr.541 ca

mis	UM	€
16410 39	1 NR	109,85
16411 40	1 NR	109,85
16412 41	1 NR	109,85
16413 42	1 NR	109,85
16414 43	1 NR	109,85
16415 44	1 NR	109,85
16416 45	1 NR	109,85
16417 46	1 NR	109,85

Scarpa Pasitos 91253-00L



- Protezione S3**
- Tomaia in Nubuk Hydrotech + Scamosciato bott Hydro
 - Fodera Aired 3D 320 gr + DualMicro
 - Suola PU Dual Density SRC Passed
 - Suoletta SoftFit anatomico
 - Puntale ALU-SXT Aluminium
 - Lamina Antiperforazione Q Zero Flex 4 EN
 - 12568:2010
 - Peso gr.541 ca

mis	UM	€
16418 39	1 NR	109,85
16419 40	1 NR	109,85
16420 41	1 NR	109,85
16421 42	1 NR	109,85
16422 43	1 NR	109,85
16423 44	1 NR	109,85
16424 45	1 NR	109,85
16425 46	1 NR	109,85

Scarpa Pasitos 91253-02L



- Protezione S3**
- Tomaia in Nubuk Hydrotech + Scamosciato bott Hydro
 - Fodera Aired 3D 320 gr + DualMicro
 - Suola PU Dual Density SRC Passed
 - Suoletta SoftFit anatomico
 - Puntale ALU-SXT Aluminium
 - Lamina Antiperforazione Q Zero Flex 4 EN
 - 12568:2010
 - Peso gr.541 ca

mis	UM	€
16426 39	1 NR	109,85
16427 40	1 NR	109,85
16428 41	1 NR	109,85
16429 42	1 NR	109,85
16430 43	1 NR	109,85
16431 44	1 NR	109,85
16432 45	1 NR	109,85
16433 46	1 NR	109,85

Espositore cartonato



per scarpe Sixton

Scarpa B186 ALTA



- Protezione S3**
- Tomaia in pelle nabuk ingrassata
 - Suola in PU monodensità
 - Fodera in tessuto 3D hi-tech
 - Puntale in acciaio EN12568 resistente a 1170 N
 - Plantare estraibile in tessuto accoppiato a materiale polimerico espanso
 - Sottopiede in fresh'n flex

TG	UM	€
15893 39	1 NR	81,26
15894 40	5 NR	77,64
15895 41	5 NR	77,64
15896 42	5 NR	77,64
15897 43	5 NR	77,64
15898 44	5 NR	77,64
15899 45	5 NR	77,64

	TG		UM	€
15900	46	5	NR	77,64

Scarpa Arena B0451



Protezione S1P
 • Tomaia in pelle scamosciata e Lycra
 • Suola Airtech biodensità
 • PU/Tpu-Skin

	TG		UM	€
16990	39	1	NR	78,94
16991	40	5	NR	77,64
16992	41	5	NR	77,64
16993	42	5	NR	77,64
16994	43	5	NR	77,64
16995	44	5	NR	77,64
16996	45	5	NR	77,64
16997	46	5	NR	77,64

Laccio scarpe

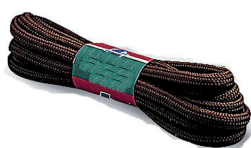

tondi colore nero arancio

	cm		UM	€
07111	130	10	CP	1,02

Soletta Fusstatic



Antistatica e Antibatterica ai carboni attivi

	mis		UM	€
06900	39	1	CP	4,99
06901	40	1	CP	4,99
06902	41	1	CP	4,99
06903	42	1	CP	4,99
06904	43	1	CP	4,99
06905	44	1	CP	4,99
06906	45	1	CP	4,99
06907	46	1	CP	4,99

Soletta imbottita



	Tg.		UM	€
61494	40	1	NR	5,33
61495	41	1	NR	5,33
61496	42	1	NR	5,33
61497	43	1	NR	5,33
61498	44	1	NR	5,33
61499	45	1	NR	5,33
61500	46	1	NR	5,33

Stivale Giallo



Protezione S5, in PVC EN 345, lamina e puntale in acciaio, suola carrarmato

	mis		UM	€
53242	39	6	NR	21,78
53243	40	6	NR	21,78
53244	41	6	NR	21,78
53245	42	6	NR	21,78
53246	43	6	NR	21,78
53247	44	6	NR	21,78
53248	45	6	NR	21,78
53249	46	6	NR	21,78

Stivale Country Alto



Gomma forte per uso professionale nei settori agricolo e forestale. Suola antiscivolo con elevato assorbimento degli urti nella zona del tallone ed inserto centrale anticorrosione e plantare anatomico.

	mis		UM	€
16296	39	1	PA	27,17
16297	40	1	PA	27,17
16298	41	1	PA	27,17
16299	42	1	PA	27,17
16300	43	1	PA	27,17
16301	44	1	PA	27,17
16302	45	1	PA	27,17
16303	46	1	PA	27,17

Stivale Forest Basso



Gomma forte per uso professionale nei settori agricolo e forestale. Suola antiscivolo con elevato assorbimento degli urti nella zona del tallone ed inserto centrale anticorrosione e plantare anatomico.

	mis		UM	€
16304	39	1	PA	24,73
16305	40	1	PA	24,73
16306	41	1	PA	24,73
16307	42	1	PA	24,73
16308	43	1	PA	24,73
16309	44	1	PA	24,73
16310	45	1	PA	24,73
16311	46	1	PA	24,73

Stivale Canadese

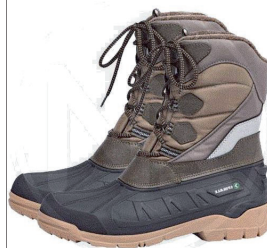

in Gomma-Poliestere - Stivale alto invernale per utilizzo a basse temperature (-30°) - Suola con profilo disegnato per mantenersi pulita e con pianta larga per una maggiore stabilità - Stivale particolarmente flessibile prodotto in tutto rispetto con l'ambiente e fabbricato con l'uso di materiali ecologici - Peso (n. 41) 1,85 kg.

	mis		UM	€
12595	38	1	NR	50,81
92878	39	5	NR	50,81
92879	40	5	NR	50,81
92880	41	5	NR	50,81
92881	42	5	NR	50,81
92882	43	5	NR	50,81
92883	44	5	NR	50,81
92884	45	5	NR	50,81
92885	46	5	NR	50,81

Borsa carpentiere



in crosta scamosciata cinghia regolabile 2 tasche

	80948		24 NR	€ 11,05
--	-------	--	-------	---------

Borsa carpentiere



in crosta scamosciata 2tasche 2 asole portamartello



84239

24 UM
NR € 15,43

Borsa porta attrezzi



in Nylon con maniglia 7 tasche 1 asola per martello 1 gancio per flessometro



92667

1 UM
NR € 8,56

Borsa carpentiere



in crosta scamosciata 4 tasche 2 asole portamartello 1 gancio per flessometro



92665

1 UM
NR € 13,50

Borsa porta attrezzi



in Nylon con maniglia 8 tasche e 1 tasca portatelefonino



92668

1 UM
NR € 8,50

Borsa carpentiere



in crosta morbida colore marrone a 2 tasche con soffietto laterale



12721

1 UM
NR € 19,20

Borsa porta attrezzi



in Nylon con maniglia 8 tasche e 1 tasca portatelefonino



92671

1 UM
NR € 28,81

Borsa carpentiere



in pelle morbida colore marrone a 3 tasche con soffietto laterale



12722

1 UM
NR € 30,27

Portacellulare Nylon



92675

7 UM
NR € 2,89

Cintura carpentiere



in crosta colore Nero



12719

1 UM
NR € 9,39

Guanto Hycron 27-600

Ansell



in nitrile palmo rivestito con polsino a maglia



05747 8

12 UM
PA € 3,87

05748 9

12 PA € 3,87

84369 10

12 PA € 3,87

Cintura carpentiere



in Pelle Extra colore Nero



12720

1 UM
NR € 12,73

Guanto Hycron 27-607

Ansell



in nitrile palmo rivestito con manichetta



05749 9

12 UM
PA € 4,10

84370 10

12 PA € 4,10

Portametro



in Pelle colore marrone



12723

1 UM
NR € 8,98

Guanto Hynit 32-815

Ansell



in nitrile ventilato dorso in materiale elastico



87707 7

12 UM
PA € 3,72

53462 7.5

12 PA € 3,72

85849 8

12 PA € 3,72

85850 9

12 PA € 3,72

85851 10

12 PA € 3,72

Guanto Hyflex



in nitrile microporoso con polso elasticizzato

Ansell

Tg	UM	€
06826 8	12 PA	4,04
06758 9	12 PA	4,04
06759 10	12 PA	4,04

Guanto Pigcrosta



dorso tela taglia 10
CE cl.1

Ansell

Tg	UM	€
83269 10	12 PA	2,66

Guanto Easy Flex



in nitrile leggeri con polso a maglia Mod. 47-200

Ansell

Tg	UM	€
86770 9	12 PA	3,28

Guanto Pelle



con palmo in pelle di capra colore bianco, dorso in nylon ed elastico al polso - Protezione contro azioni lesive di lieve entità
EN388 - Rischi Meccanici - 1111

Ansell

tg	UM	€
93585 9	12 NR	8,93

Guanto Neotop



in neoprene felpato Mod. 29-500

Ansell

Tg	UM	€
84363 7,5/8	12 PA	3,02
84364 8,5-9	12 PA	3,02
84365 9,5/10	12 PA	3,02
85893 10,5/11	12 PA	3,02

Guanto Nimax



Fodera in cotone - Resistente ai tagli, acidi e alle abrasioni - con manichetta
EN420 - EN 388 Rischi Meccanici - 3111

Ansell

Tg	UM	€
87270 10	12 PA	3,01

Guanto fiore



bianco non foderato
EN420 - EN388 Rischi Meccanici - 2122

Ansell

Tg	UM	€
89079 10	10 PA	5,71

Guanto Niwork



in nitrile leggero con polsino e fodera in cotone
EN420 - EN388 Rischi Meccanici - 3111

Ansell

Tg	UM	€
89091 10	12 PA	2,08

Guanto fiore



dorso tessuto stretch con velcro palmo rinforzato
CE - cl. 1

Ansell

Tg	UM	€
91778 10	12 PA	8,26

Guanto lattice



in cotone palmo lattice con manichetta
EN420 - EN 388 Rischi Meccanici - 3131

Ansell

Tg	UM	€
80202 10	12 PA	2,77

Guanto fiore



dorso maglia cotone con velcro
EN420 - EN388 Requisiti Meccanici - 3111

Ansell

Tg	UM	€
91777 10	12 PA	7,46

Guanto Gripper



maglia cotone palmo in lattice ad alta presa di tenuta
EN420 - EN388 Rischi Meccanici - 2421

Ansell

Tg	UM	€
87900 10	12 PA	3,01

Guanto fiore



alta visibilità
CE cl.1

Ansell

TG	UM	€
91773 10	12 PA	6,61

Guanto Glovex



in nitrile fodera filo nylon
EN420 - EN388 Rischi meccanici - 4121 colore bianco

Ansell

Tg	UM	€
89323 8	12 PA	1,21
89324 9	12 PA	1,21
89090 10	12 PA	1,21

Guanto Glovex



in nitrile fodera filo nylon
EN420 - EN388 Rischi meccanici - 4121 colore nero

Tg	UM	€
94807 8	12 PA	1,29
94808 9	12 PA	1,29
94809 10	12 PA	1,29

Guanto Seattle



in poliuretano fodera filo nylon colore grigio/nero
EN420 - EN 388 Rischi Meccanici - 4131

Tg	UM	€
92973 8	12 PA	1,29
92974 9	12 PA	1,29
92975 10	12 PA	1,29

Guanto Seattle



in poliuretano fodera filo nylon colore bianco
EN420 - EN388 Rischi Meccanici - 4131

Tg	UM	€
89321 8	12 PA	1,17
89322 9	12 PA	1,17
89092 10	12 PA	1,17

Guanto Winter



in acrilico imbottito senza cuciture - Colore arancio - Palmo ricoperto in schiuma di lattice - Polsino elasticizzato - Super isolamento dal freddo anche a temperature molto basse - Ottima presa, traspirabilità, flessibilità e comodità.
EN388 - Requisiti meccanici - 2131

Tg	UM	€
94388 8	12 PA	4,72
94389 9	12 PA	4,72
94390 10	12 PA	4,72

Guanto Hi-Grip



in poliestere senza cuciture - Palmo ricoperto in schiuma di lattice - Polsino elasticizzato - Ottima presa, aderenza e flessibilità.
EN 388 - Requisiti meccanici -2121

Tg	UM	€
94385 8	12 PA	2,69
94386 9	12 PA	2,69
94387 10	12 PA	2,69

Guanto Grippflex



in filo continuo nylon senza cuciture - Palmo ricoperto in lattice - Polsino elasticizzato - Ottima presa, aderenza e flessibilità.
EN 388 - Requisiti meccanici - 2131

Tg	UM	€
94391 8	12 PA	2,38
94392 9	12 PA	2,38
94393 10	12 PA	2,38

Guanto Nitrofit



in filo continuo nylon senza cuciture - Palmo ricoperto in nitrile - Polsino elasticizzato - Ottima resistenza all'abrasione e all'usura, aderenza e flessibilità.
EN 388 - Requisiti meccanici - 4121

Tg	UM	€
94382 8	12 PA	3,43
94383 9	12 PA	3,42
94384 10	12 PA	3,43

Guanto Nitrile Pesante



Dorso in nylon - Chiusura al polso con velcro - Protezione contro azioni lesive di lieve entità - con polsino
EN388 - Rischi Meccanici - 4121

tg	UM	€
93590 9	12 NR	6,83

Guanto Nitrile per alimenti



Resistenti alle sostanze chimiche - Idonei per uso alimentare - Finitura esterna del palmo e delle dita con grip diamantato per una migliore presa - Manichetta larga - Comfortevoli e duraturi - Ampia gamma di applicazione - EN388 Rischi Meccanici - 4001
EN374 Rischi Chimici - KLA

tg	UM	€
93591 8	12 NR	2,29
93592 9	12 NR	2,29
93593 10	12 NR	2,29

Sottoguanto



in cotone bianco con polsino taglia 10
CE cl.1

Tg	UM	€
91776 10	12 PA	1,46

Guanto Vinile



ambidetro monouso con bordino, non sterili
CE cl.1 - Cf. in scatola da 100 pz.

Tg	UM	€
90884 7,5	10 CF	7,24
87274 8,5	10 CF	7,24
90885 9,5	10 CF	7,24

Guanto lattice



in puro lattice 100% ambidestro monouso supersensibili
CE cl.1 - Cf. in scatola da 100 pz.

Tg	UM	€
90887 7,5	10 CF	9,18
87275 8,5	10 CF	9,18
90888 9,5	10 CF	9,18

Guanto Nitrile



Monouso - In nitrile 100% - Extra sensibili - Finitura interna liscia - Finitura esterna con microgrip sulle dita - Privo di polvere - Non sterile - Uso alimentare - Guanti medicali classe 1 - EN 455 - Cf. in scatola da 100 pz.

Tg	UM	€
94353 7,5	1 CF	9,40
94354 8,5	1 CF	9,40
94355 9,5	1 CF	9,51

Guanto Nitrile



in nitrile blu 100% ambidestro monouso supersensibile
CE cl.1 - Cf. in scatola da 100 pz.

Tg	UM	€
91871 7,5	10 CF	11,64
91872 8,5	10 CF	11,64
91873 9,5	10 CF	11,64

Disco abrasivo Ferro



da taglio - foro mm.22,23

mm	UM	€
89258 115x1	25 NR	1,28
87268 115X1,6	25 NR	1,25
92169 115X2,5	25 NR	1,18
92170 230X2,5	25 NR	2,18

Disco abrasivo Ferro



per levigatura - foro mm.22,23

mm	UM	€
85754 115X6	25 NR	1,82
87259 230X6	10 NR	4,32

Disco abrasivo Inox



per taglio acciaio inox - foro mm.22,23

MM	UM	€
89259 115X1	25 NR	1,32
88547 115X1,6	25 NR	1,28
88548 230X1,9	25 NR	2,64

Disco abrasivo Marmo



per taglio - foro mm.22,23

mm	UM	€
88911 115X1,6	25 NR	1,32
85760 115X3	25 NR	1,32
85764 230X3	25 NR	2,93

Disco abrasivo Multifunzione



per taglio acciaio, inox, alluminio, pietra, plastica

mm	UM	€
93084 115X1,0	25 NR	1,61

Disco abrasivo



per smerigliatrice a batteria Bosch GWS 14,4

mm	Taglio	UM	€
07882 100	metallo	1 NR	2,92
07883 100	inox	1 NR	3,36
07884 100	diamantato	1 NR	51,15

Disco Zec



per sgrossatura e levigatura del cemento non richiede alcun supporto e viene montato direttamente sulla smerigliatrice. EN13743

mm	gr	UM	€
04275 115X22	24	5 NR	6,42
04276 178X22	24	5 NR	8,43

Disco diamantato Turbo



Impiego per taglio a umido e a secco - Ottimo per cemento, tegole e granito

mm	UM	€
86738 115x2,2	10 NR	10,19
86739 230x2,6	1 NR	27,73

Disco diamantato Silenziato



Anima in acciaio speciale - Impiego per taglio a umido e a secco - Ottimo per marmo, piastrelle, ceramica, tegole, ardesia, porcellana.

mm	UM	€
88577 115x1,2	1 NR	18,47

Disco diamantato Silenziato



Anima in acciaio speciale - Impiego per taglio a umido e a secco - adatto per granito, pietra, mattone pieno, calcestruzzo, tegole

mm	UM	€
91763 230X2,8	10 NR	58,78

Disco diamantato Ceramica



Impiego per taglio a umido e a secco - Ottimo per ceramica e piastrelle

	mm			UM	€
86737	115X1,6		1	NR	6,03

Disco diamantato Gres



Impiego per taglio a umido e a secco - Ottimo per gres e ceramica

	mm			UM	€
93830	115x1,2		5	NR	21,24

Disco diamantato Cemento



segmenti saldati Laser, semiprofessionale, adatto per mattoni a vista, materiali edili, refrattari, spess.mm. 3,2 foro mm. 25,4

	mm			UM	€
04692	300		1	NR	205,49
04693	350		1	NR	258,32

Lama Widia



per sega circolare denti al carburo di tungsteno - Dentatura alternata con limitatore per legno duro e tenero, senza possibilità di contraccolpi

	mm	Z	foro		UM	€
81190	160	24	30/20/16	1	NR	33,68
81191	180	24	30/20/16	1	NR	33,68
85281	190	24	30/20/16	1	NR	39,29
81193	250	60	30	1	NR	85,51
81195	300	48	30	1	NR	70,98
89763	315	48	30	1	NR	74,61
81197	350	54	30	1	NR	85,51
83604	400	32	30	1	NR	89,47
05511	450	54	30	1	NR	148,90

Riduzione



per lama circolare

	mm			UM	€
81774	30-16		1	NR	4,95
81771	30-20		1	NR	4,95
03303	30-25		1	NR	4,95

Mola smeriglio



	mm	GR		UM	€
02670	125X20	80	1	NR	21,45
02673	150X20	80	1	NR	23,87
02677	200X20	80	1	NR	39,27
11435	Riduz.	16/13	10	NR	0,24

Mola smeriglio



al Widia

	mm	GR		UM	€
02666	125X20	80	1	NR	28,71
02667	150X20	80	1	NR	34,21
02669	200X20	80	1	NR	56,32

Mole rotative



al corindone in set pz.5 gambo mm.3

	mm		UM	€
80905		1	NR	3,52

Pietra abrasiva



ad olio

	mm		UM	€
80904		10	NR	1,72

Banco sega TSB 315



- Motore a spazzole
- Lama Widia mm. 315 inclinabile 45°
- Piano di lavoro in lamiera acciaio con estensione: 800x550/400 mm.
- Guida parallela reversibile utilizzabile come squadratore
- Doppia bocchetta di aspirazione
- Basamento c/manici e ruote per un più facile spostamento mm
- Altezza max taglio a 0°: 83 mm., 45°: 60 mm.
- Potenza Watt 2000
- Giri 2860 rpm

		UM	€
94545	1	NR	414,66

Betoniera portatile mod.MX140



- Verniciatura a polveri - Motore a induzione potente con protezione termica - Leggera per facile trasporto - Interamente in acciaio - Ruote grandi per maggiore mobilità - Tamburo: (velocità 26g/min. - Spessore sup/inf 1,5/2 mm.)
- Peso 54 kg.
- Potenza Watt 375
- Vasca Lt.140
- Bocca diam.350

		UM	€
94458	1	NR	444,49

Betoniera portatile mod.MR160C



- motore ad induzione potente con protezione termica - peso ridotto per facile trasporto - componenti in acciaio per maggiore durata nel tempo - grandi ruote per un facile trasporto - ghiera in ghisa per una rotazione regolare e silenziosa - verniciatura a polveri - betoniera per uso hobbistico e non può essere utilizzata per uso professionale in cantiere
- Potenza Watt 550
- Vasca Lt.160
- Bocca diam.375

	largh.cm.		UM	€
94414	70	1	NR	459,66

Elevatore Hobby 125/250



- Kg.125/250 fune mt.18
- Pulsantiera pensile
- Potenza Watt 500
- Velocità salita 10 mt./min
- Servizio intermittente periodico S-3 20%
- Tensione 230 V-50 Hz
- Peso Kg.23

089421	1	UM NR	€ 157,20
--------	---	-------	----------



Elevatore DM200I VELOX



- DM200I VELOX
- Portata Kg.200
- Velocità salita 40 mt./min
- Motore elettrico monofase Kw 0,75
- Lunghezza fune mt.25 diam. mm.5
- Peso Kg.43

08995	1	UM NR	€ 1016,83
-------	---	-------	-----------

Elevatore Hobby 250/500



- Kg.250/500 fune mt.18
- Pulsantiera pensile
- Potenza Watt 900
- Velocità salita 10 mt./min
- Servizio intermittente periodico S-3 25%
- Tensione 230 V-50 Hz
- Peso Kg.34

91422	1	UM NR	€ 237,91
-------	---	-------	----------

Cavalletto



- Portata Kg.300
- Lunghezza mm.3000
- Larghezza mm.1580
- Altezza mm.208
- Peso Kg.87
- Tubo sostegno mm.48

08997	1	UM NR	€ 776,17
09006 coppia traversini	1	NR	€ 85,09



Bandiera



per elevatore Yamato completa di morsetti

mm	portata	UM	€
91436	750 Kg.600	1 NR	43,60
07674	1100 Kg.300	1 NR	62,57

Portasecchi



post	UM	€
09003 2	1 NR	87,46
09004 3	1 NR	125,73
09005 4	1 NR	165,40



Elevatore DM150/200 VELOX



- Portata Kg.150
- Velocità salita 40 mt./min
- Motore elettrico monofase Kw 1,45
- Lunghezza fune mt.25 diam. mm.5
- Peso Kg.40

08993	1	UM NR	€ 917,06
-------	---	-------	----------



Bandiera B2



completa di morsetti lunghezza mm.900

08998	1	UM NR	€ 163,38
-------	---	-------	----------



Elevatore DM200I



- Portata Kg.200
- Velocità salita 25 mt./min
- Motore elettrico monofase Kw 0,75
- Lunghezza fune mt.25 diam. mm.5
- Peso Kg.37

08994	1	UM NR	€ 830,60
-------	---	-------	----------



Bandiera B4

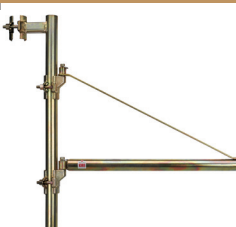

con tirante completa di morsetti - Lunghezza mm.790

09001	1	UM NR	€ 122,85
-------	---	-------	----------



Elevatore DM200E

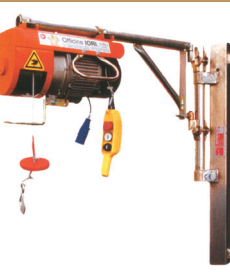

- Portata Kg.200
- Velocità salita 21 mt./min
- Motore elettrico monofase Kw 0,75
- Lunghezza fune mt.25 diam. mm.4
- Peso Kg.23

08992	1	UM NR	€ 676,51
-------	---	-------	----------



Bandiera

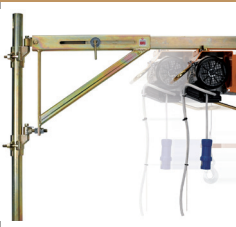

estensibile mm.900/1200 con tiranti completa di morsetti

09002	1	UM NR	€ 273,84
-------	---	-------	----------



Morsetti



per bandiera in coppia

08996	1	UM NR	€ 73,05
-------	---	-------	---------



Ruote



per cavalletto in coppia



Articolo	UM	€
09000	1 CP	89,41

Pulsantiera

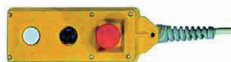

2 Tasti con arresto d'urgenza



Articolo	UM	€
08999	1 NR	454,12

Paranco a catena



- Alzata mt.3
- Portata Kg.1000
- Catena mm.6x18
- Peso Kg.15

Articolo	UM	€
89348	1 NR	142,88

Argano



a manovella in acciaio alta resistenza

Articolo	UM	€
83579 550	1 NR	87,33
86821 1100	1 NR	177,27

Levicino carpentiere



in acciaio forgiato

Articolo	UM	€
50165 50	12 NR	4,92
50166 60	12 NR	5,91
50167 70	12 NR	7,30
53563 80	12 NR	8,64
02802 100	12 NR	10,48

Leva unghia chiusa



Articolo	UM	€
50175 120	1 NR	33,54
50176 150	1 NR	43,87

Leva unghia aperta



Articolo	UM	€
50172 120	1 NR	33,54
50173 150	1 NR	43,87

Cambre tetto



Articolo	UM	€
50666 25	25 KG	6,01
50667 30	25 KG	6,01
50668 35	25 KG	6,01
02805 40	25 KG	6,01

Carrucola sicurezza

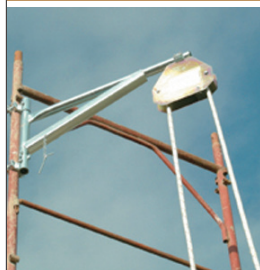

- con freno autobloccante
- Portata utile massima Kg.50
 - Altezza massima utilizzabile Mt.30
 - Diametro funi utilizzabile mm. 18/20
 - Fissaggio su ponteggi omologati con diametro est. 48
 - Peso Kg.4

Articolo	UM	€
10684 50	1 NR	173,26

Carrucola ghisa



Articolo	UM	€
52969 100	1 NR	14,58
50208 120	1 NR	16,40
50209 145	1 NR	20,96
50211 180	1 NR	29,14
50212 200	1 NR	34,61

Fermaneve preverniciato



Articolo	UM	€
53538 marsigliese	50 NR	1,24
53539 cemento	50 NR	1,24
53540 portoghese	50 NR	1,24
53541 coppo	50 NR	1,24

Fermaneve rame



per tegola coppo

Articolo	UM	€
53545	50 NR	6,03

Fermacoppo rame



Articolo	UM	€
53581 9	1000 NR	0,32
53580 20	500 NR	0,52

Fermacoppo preverniciato



Articolo	cm	UM	€
00030	9	1000 NR	0,09

Distanziale



Articolo	cm	UM	€
53409	20	100 NR	0,25
53410	25	100 NR	0,28
53411	30	100 NR	0,32
53412	35	100 NR	0,35
53413	40	100 NR	0,39
53414	45	100 NR	0,42

Carriola Tubolare



verniciata vasca in lamiera lt.70 ruota pneumatica - Vasca bordo chiuso

Articolo	UM	€
50197	1 NR	48,73

Carriola pesante



profilo angolare vasca lt.70 ruota pneumatica

Articolo	UM	€
52952	1 NR	60,83

Carriola ribaltabile



con ruota pneumatica

Articolo	UM	€
52953	1 NR	68,59

Vasca Carriola



Bordo chiuso leggera

Articolo	UM	€
50226	1 NR	16,96

Ruota Carriola



Articolo	tipo	UM	€
50203	piena	1 NR	24,60
50202	pneumatica	1 NR	15,88

Ruota carriola



piena in poliuretano

Articolo	UM	€
94704	1 NR	32,08

Ricambi carriola



Articolo	tipo	UM	€
06872	boccola	1 NR	0,37
12203	manopola	1 NR	0,37

Mordignone doppio



verniciatura a polvere a forno

Articolo	mm	UM	€
50096	6/8	1 NR	5,08
50097	10/12	1 NR	7,30
50098	14/16	1 NR	9,53

Mordignone semplice



verniciatura a polvere a forno

Articolo	mm	UM	€
50088	10	1 NR	5,27
50089	12	1 NR	5,97
50090	14	1 NR	8,42
50091	16	1 NR	11,02
50092	18	1 NR	14,54
50093	20	1 NR	16,32

Piastra piegaferro

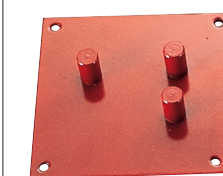

semplice con bussola mm.180x180

Articolo	UM	€
52849	1 NR	10,02

Piegaferro a leva



con manico piegatura verniciatura a polvere a forno max diametro tondo 22

Articolo	UM	€
50144	1 NR	99,62

Piegastaffe Rapid



con manico piastra in acciaio verniciatura a polvere a forno piegatura max diametro tondo 12

Articolo	UM	€
52851	1 NR	52,10

Segoncino doppio uso

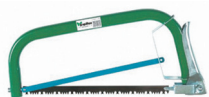

con lama per taglio legno e ferro cm.30

Articolo	cm	UM	€
02844	30	15 NR	7,08

Segoncino girevole



telaio tubolare con leva di tensione attacco portalama girevole con lama cm.53

Articolo	cm	UM	€
01746	53	20 NR	6,21

Segoncino fisso



telaio tubolare con leva di tensione attacco portalama fisso

Articolo	CM	UM	€
83108	53	20 NR	6,21
80672	61	15 NR	8,17
91645	76	15 NR	9,08
02198	80	12 NR	9,44
02214	90	12 NR	10,53

Lama segoncino



Articolo	cm	UM	€
01747	30	10 NR	1,27
50443	53	10 NR	1,78
01750	61	10 NR	1,98
91650	76	10 NR	2,32
01752	80	10 NR	2,43
01753	90	10 NR	2,58

Lama segoncino



Articolo	cm	mod	UM	€
03716	53	51-21	10 NR	9,98
03717	61	51-24	10 NR	10,66
03718	76	23-30	10 NR	11,83
03719	80	51-32	10 NR	12,57
03720	90	23-36	10 NR	13,43

Setaccio muratore



fascia in legno diametro cm.30

Articolo	NR	Rete	UM	€
50184	4/0	1,8x1,8	10 NR	15,94
53571	3/0	2x2	10 NR	15,94
50185	2/0	3x3	10 NR	15,94
50186	0	4x4	10 NR	15,94
53572	1	5x5	10 NR	15,94
53573	2	6x6	10 NR	15,94
04448	3	7x7	10 NR	15,94

Rete arancio

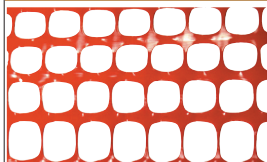

in plastica maglia ovale per delimitazione cantieri

Articolo	mt	UM	€
87908	1,2X50	1 NR	63,01
87909	1,5X50	1 NR	78,76
87910	1,8X50	1 NR	94,51

Rete verde

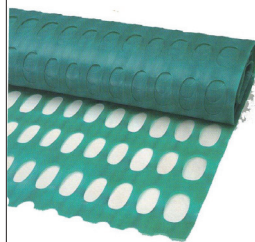

in plastica maglia ovale per delimitazione cantieri

Articolo	mt	UM	€
55532	1,8x50	1 RT	100,07

Rete ponteggi



schermante in HPDE monofilo, stabilizzata ai raggi UV, cimosà cm.4,5, occhielli metallici sui bordi ogni 90 cm.

Articolo	MT	colore	UM	€
91990	25	bianco	8 RT	44,11
91991	25	verde	8 NR	44,75

Rete antipolvere



per edilizia in polietilene con occhielli in alluminio, stabilizzata UV 85 gr/mq, cordino di rinforzo sui due lati

Articolo	MT	H	UM	€
91952	25	1,8	5 NR	42,04

Rete portaintonaco

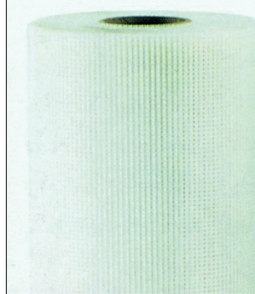

in fibra vetro - H.1x50 mt bianca -

Articolo	gr	maglia	UM	€
91562	75 mq	3,5X4,5 mm	60 RT	42,16

Rete portaintonaco

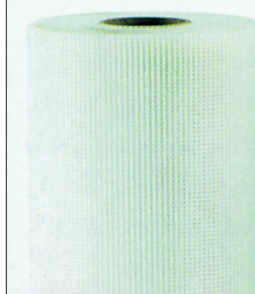

in fibra vetro - H.1x50 mt bianca - ETAG 004 - ITC-CNR

Articolo	gr	MG	UM	€
55067	150 mq	4x4,5 mm	33 RT	59,40

Rete portaintonaco blu

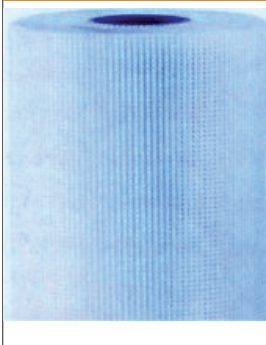

in fibra vetro Trattata con resina antialcalina - Carico di rottura certificato norme DIN EN ISO 13934-1 - H.1x50 mt blu

art	cm	UM	€
55068	120 mq	10X10 mm 21 RT	50,34

Nastro adesivo

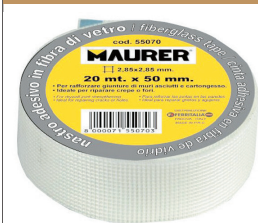

in fibra di vetro mm.50 maglia 2,85x2,85

MT	UM	€
55070 20	72 RT	1,47
55069 90	24 RT	5,11

Tenaglia Mod.33

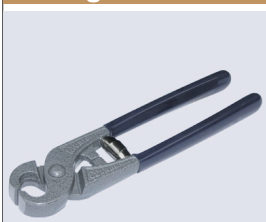

per piastrellisti, realizzata in acciaio forgiato di alta qualità, manico con rivestimento in PVC per una presa più confortevole e sicura

art	UM	€
50247	1 NR	30,90

Tagliategole mod.32



progettata per il taglio di tegole in cotto di ogni formato

art	UM	€
50248	1 NR	120,33

Tagliapiastrelle Mini



Questa gamma di macchine consente di tagliare senza alcuna regolazione piastrelle di diversi spessori 0-20 mm secondo diverse angolazioni 0-60° grazie a linee indicatrici di riferimento

art	cm	UM	€
50237 26A	36x36	6 NR	110,57
53144 43A	45x45	2 NR	159,36

Tagliapiastrelle Master

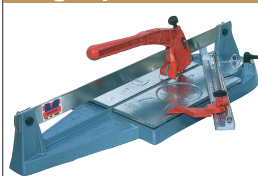

taglia tutti i tipi di piastrelle attualmente sul mercato siano esse in ceramica smaltata, gres, monocottura, cotto o simili. Ideale soprattutto per piastrelle di alto spessore od estremamente tenaci.

art	cm	UM	€
50238 31	30x30	2 NR	370,75
50239 34	40x40	2 NR	416,28
50241 47M	62x62	1 NR	614,66

Tagliapiastrelle Piuma



questa gamma di macchine superprofessionali può tagliare con precisione e rapidità tutti i tipi di piastrelle con spessore mm. 0-20, grazie alla squadra goniometrica di generose dimensioni, anche il taglio diagonale risulta semplice e sicuro

art	cm	UM	€
04733 52P	52x52	1 NR	374,00
04734 75P	75x75	1 NR	495,95

Portarotelle mod.261



per tagliapiastrelle art.31

art	UM	€
53150	1 NR	43,84

Portarotelle mod.262



per tagliapiastrelle Art. 34-46-47

art	UM	€
53151	1 NR	62,39

Rotella ricambio



Mod	UM	€
50246 master	12 NR	8,43
50245 29 diam.8-12	12 NR	7,59
50244 Mini/piuma	12 NR	8,43

Ventosa semplice



corpo in nylon mm.100 portata kg.40

KG	UM	€
86177 40	1 NR	4,40

Ventosa doppia



corpo in nylon mm.100 portata kg.80

KG	UM	€
87159 80	1 NR	42,44

Ventosa tripla



corpo in nylon mm.100 portata kg.110

KG	UM	€
87160 110	1 NR	49,08

Spugna sintetica



in poliesteri colore Tabacco

Mod	cm	UM	€
05348	16x11x5	25 NR	1,48

Spugna lattice

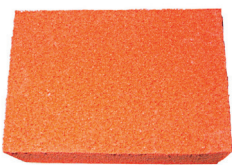

in gomma naturale colore Orange

Mod	cm	UM	€
06461	16x11x5	15 NR	7,10

Paglietta



in lana acciaio

Mod	tipo	UM	€
53163	nazionale grossa 01	10 KG	6,97
11479	americana fine 00	10 KG	6,31

Paglietta



in matassina gr.75/80

Mod	tipo	UM	€
11481	americana fine 00	50 CF	0,96
11480	nazionale grossa 01	50 CF	0,96

Cuneo livellamento



per piastrelle in busta da pz.500

Mod	UM	€
09082	500 NR	0,01

Distanziatore a T



per piastrelle in busta pz.250

Mod	mm	UM	€
53168	2	1 CF	1,25
05217	3	1 CF	1,25
05218	5	1 CF	1,47
05219	7	1 CF	2,17

Distanziatore a croce

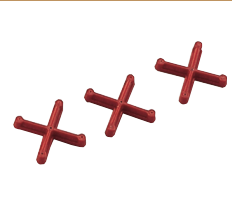

per piastrelle in busta pz.250

Mod	mm	UM	€
53173	2	1 CF	1,25
05214	3	1 CF	1,25
05215	5	1 CF	1,47
05216	7	1 CF	2,17

Distanziatore cassero



in PVC

Mod	mm	UM	€
06749	20	1000 NR	0,03
06750	25	1000 NR	0,04

Supporto quadrotti



Mod	UM	€
53560	260 NR	0,23

Distanziatore cassero

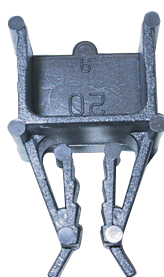

a torre in PVC

Mod	mm	UM	€
06752	20	1000 NR	0,04
06753	25	1000 NR	0,05

Parapetto anticaduta



zincato colore bianco/giallo, lunghezza cm.100

Mod	sez	Bancale	UM	€
07741	35X35	125	1 NR	26,25

Chiusino zincato

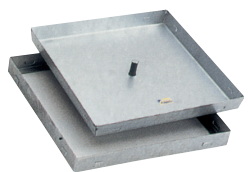

in lamiera zincata spessore 10-12/10 pressopiegata e con lembi fissati mediante sistema di bloccaggio brevettato (Punto "TOX"), completi di telaio in lamiera zincata spessore 15/10. I fondelli sono muniti di foro centrale per il sollevamento mediante Euroclipper o Vite.

Mod	cm	H	UM	€
53508	23X23	50	10 NR	15,27
53509	33X33	50	10 NR	20,42
53510	43X43	50	10 NR	25,73
53511	53X53	50	10 NR	35,38

Chiusino piano Zincato

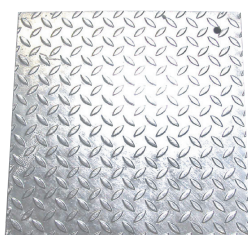

in lamiera bugnata spessore 25/10 completa ti telaio in angolare h. 15 mm., il tutto zincato a caldo a norme UNI ISO EN 1461.

Mod	cm	H	UM	€
53503	25X25	50	1 NR	21,90
53504	35X33	50	1 NR	34,16
53505	45X45	50	1 NR	50,94
53506	55X55	50	1 NR	70,26

fischer T-BOND

Ancorante chimico ibrido
certificato CE

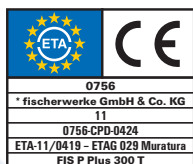

- **Marcatura CE.** fischer T-BOND è certificato CE su muratura piena e, abbinato al tassello a rete fischer FIS HK, su muratura forata. La capacità portante del sistema T-BOND più barra filettata (M8 ÷ M16) è certificata da un ente esterno e garantita per una durata di almeno 50 anni.
- **Formulazione ibrida.** Il Cemento Portland nella formulazione chimica di T-BOND conferisce minore sensibilità alla pulizia del foro, maggiori prestazioni meccaniche e una più alta resistenza alle sostanze aggressive.
- **Uso facile e veloce: pronta all'uso.** L'apertura della confezione non richiede alcun tipo di utensile (forbice o cutter) grazie al sistema brevettato.
- **Zero spreco.** T-BOND può essere riutilizzata più volte e con il minimo sforzo di estrusione è possibile utilizzare l'intero contenuto della confezione.
- **Zero stirene.** T-BOND non è tossica e non emana cattivi odori, può essere utilizzata in ambienti chiusi o poco aerati.
- **Ottima tixotropia.** T-BOND non cola ed è ideale per installazioni anche a soffitto.
- **Pratica.** Ogni cartuccia di T-BOND è fornita con due miscelatori per eseguire più applicazioni.
- **Formato silicone.** T-BOND può essere facilmente estrusa con la pistola standard da silicone o con la pistola professionale fischer.

fischer SXR

Tassello prolungato in nylon
per serramenti e carpenteria leggera



- **Elevatissimi valori di resistenza** a taglio e a trazione.
- **Velocità di installazione** e bassa coppia di serraggio.
- **Testato su oltre 40 materiali** da costruzione
- **Vasta gamma di misure viti e accessori:** diametri da 6 a 10 mm, viteria con impronta Pozo e Torx, in acciaio zincato e inox A4.
- Spessori fissabili da 2 a 210 mm
- **Durabilità garantita** dall'ETA 07/0121, Benestare Tecnico Europeo
- **Resistenza al fuoco F90.**

fischer SX

Tassello ad espansione
in nylon



- L'espansione a 4 settori **garantisce elevati valori di tenuta.**
- Le **speciali alette antirotazione** impediscono al tassello di ruotare all'interno del foro.
- Il collare impedisce al tassello di penetrare nel foro.
- La qualità del nylon garantisce **anni di sicurezza ed affidabilità.**
- **Resistente alle temperature** da -40°C a +80°C.

fischer TAM

Tassello ad espansione in acciaio



- **TAM è marcato CE** avendo ottenuto il benestare tecnico europeo opzione 7 per calcestruzzo non fessurato.
- **Classe di resistenza al fuoco F120.**
- Bugnature di aggancio per una **migliore aderenza nel foro.**
- Nervature per il centraggio dell'accessorio.
- **Tappo in materiale plastico** per proteggere la filettatura interna dalla polvere, nella versione con e senza vite TE.
- Il sistema di espansione a 3 settori **permette una distribuzione uniforme del carico** e distanze minime dal bordo e tra interassi.
- **Vasta gamma di accessori.**
- TAM M8 BP, specifico fissaggio antintrusione per l'installazione di inferriate.

Fischer Italia srl Unipersonale
Corso Stati Uniti, 25 - 35127 Padova
Fax +39 049 8063401
www.fischeritalia.it
www.facebook.com/fissaggio
www.youtube.com/fissaggiofischer



fischer 
innovative solutions

Tassello Fischer Mod. S



Tassello in nylon

mod	UM	€
01936 4	100 NR	0,05
01938 5	100 NR	0,05
01941 6	100 NR	0,05
01946 8	100 NR	0,08
01928 10	50 NR	0,14
01935 12	25 NR	0,26
12958 14	20 NR	0,57

Tassello Fischer Mod.SC



Tassello in nylon con collare

mod	UM	€
01939 5	1000 NR	0,02
01942 6	1000 NR	0,02
01947 8	1000 NR	0,04

Tassello Fischer Mod.SV

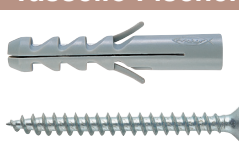

Tassello in nylon con vite per truciolare TPS con impronta Pozidrive

mod	UM	€
01925 5	100 NR	0,13
01926 6	100 NR	0,13
01927 8	50 NR	0,19
01924 10	25 NR	0,48

Tassello Fischer Mod.SX



Tassello in nylon

mod	UM	€
10218 5	100 NR	0,05
06404 6	100 NR	0,06
06405 8	100 NR	0,09
06406 10	50 NR	0,15
06407 12	25 NR	0,28

Tassello Fischer SX-S



Tassello in nylon con vite truciolare TPS con impronta Pozidrive

mod	UM	€
10219 5	100 NR	0,14
06408 6	100 NR	0,14
06409 8	50 NR	0,21
12903 10	25 NR	0,51

Tassello Fischer Mod.FU-V



Tassello in nylon con vite per truciolare TPS impronta a croce

mod	UM	€
01827 6X35V	100 NR	0,26
01828 6X45V	100 NR	0,29
01829 8X50V	50 NR	0,35
01826 10X60V	25 NR	0,58

Tassello Fischer Mod.PD-S

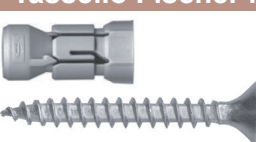

Tasselli in nylon per cartongesso con vite truciolare TPS con impronta Pozidrive

mod	UM	€
09998 8S	50 NR	0,53
09999 10S	50 NR	0,56
10000 12S	25 NR	0,67

Tassello Fischer Mod.S4G



Tassello appendiquadri con gancio ottonato in Conf.Pz.10

mod	UM	€
01937	10 NR	3,18

Tassello Fischer Mod.SB-4



Tassello in nylon con vite TSC taglio combinato

mod	UM	€
01899 9/4	100 NR	0,22
01888 12/4	100 NR	0,35

Tassello Fischer Mod.SB-5



Tassello in nylon con vite doppia M4

mod	UM	€
01900 9/5	50 NR	0,37
01889 12/5	50 NR	0,61

Tassello Fischer Mod.SBL9/4



Tassello in nylon prolungato con vite TSC taglio combinato

mod	UM	€
01892	100 NR	0,33

Tassello Fischer Mod.SBL9/8



Tassello in nylon prolungato gancio corto

mod	UM	€
01893	100 NR	0,33

Tassello Fischer Mod.SBN



Tassello in nylon per Cartongesso

mod	Gancio	UM	€
06689 9/2	medio	200 NR	0,28
06690 9/8	corto	200 NR	0,28

Tassello Fischer Mod.SB 9/11



Tassello fermaporta in nylon nero

mod	UM	€
01895	50 NR	0,60

Tassello Fischer Mod.SB 9/12



Tassello fermaporte in nylon bianco

mod	UM	€
01896	50 NR	0,60

Tassello Fischer Mod.SB-8



Tassello in nylon gancio corto

mod	UM	€
01902 9/8	100 NR	0,22
01891 12/8	100 NR	0,32

Tassello Fischer Mod.SB-2 



Tassello in nylon gancio medio

mod	UM	€
01897 9/2	100 NR	0,24
01886 12/2	100 NR	0,36

Tassello Fischer Mod.SB-6 



Tassello in nylon gancio lungo

mod	UM	€
01901 9/6	50 NR	0,28
01890 12/6	50 NR	0,42

Tassello Fischer Mod.SB-1 



Tassello in nylon occhiolo aperto

mod	UM	€
01894 9/1	100 NR	0,28
01885 12/1	50 NR	0,45

Tassello Fischer Mod.SB-3 



Tassello in nylon occhiolo chiuso

mod	UM	€
01898 9/3	100 NR	0,27
01887 12/3	50 NR	0,43

Tassello Fischer Mod.SBS-1 



Tassello in acciaio occhiolo aperto

mod	UM	€
01872 8/1	50 NR	0,39
01878 9/1	50 NR	0,49

Tassello Fischer Mod.SBS-2 



Tassello in acciaio gancio medio

mod	UM	€
01873 8/2	100 NR	0,35
01879 9/2	100 NR	0,38

Tassello Fischer Mod.SBS-3 



Tassello in acciaio occhiolo chiuso

mod	UM	€
01874 8/3	50 NR	0,39
01880 9/3	50 NR	0,49

Tassello Fischer Mod.SBS-4 



Tassello in acciaio con vite TSC taglio combinato

mod	UM	€
01875 8/4	100 NR	0,35
01881 9/4	100 NR	0,37

Tassello Fischer Mod.SBS-5 



Tassello in acciaio con vite doppia

mod	UM	€
01876 8/5	50 NR	0,57
01882 9/5	50 NR	0,59

Tassello Fischer Mod.SBS-6 



Tassello in acciaio gancio lungo

mod	UM	€
01883 9/6	50 NR	0,43

Tassello Fischer Mod.SBS-8 



Tassello in acciaio gancio corto

mod	UM	€
01877 8/8	100 NR	0,35
01884 9/8	100 NR	0,37

Tassello Fischer Mod.FUR-T 



Tassello prolungato in nylon per sarramenti con vite premontata TSP con impronta Torx

mod	UM	€
01980 10X80T	50 NR	1,07
01971 10X100T	50 NR	1,17
01981 10X135T	50 NR	1,32
01982 10X160T	50 NR	2,02

Tassello Fischer Mod.SXR WT Is 



Tassello prolungato in nylon con vite TPS impronta Torx Certificato

mod	UM	€
12576 6X60	100 NR	0,28
12577 8X60	50 NR	0,36
12578 10X100	50 NR	0,75
12579 10X140	50 NR	0,98
12580 10X160	50 NR	1,28

TASSELO IN NYLON CF.PEZZI 2000 



mod	UM	€
09280 N5-27	2000 NR	0,06
09281 N6-37	2000 NR	0,06

Tassello Fischer Mod.N 



Tassello in nylon con vite a chiodo premontata

mod	UM	€
01850 4X35	100 NR	0,08
01851 5X50	100 NR	0,15
01853 6X35	100 NR	0,18
01852 6X60	100 NR	0,19
01854 6X80	100 NR	0,21
01858 8X60	100 NR	0,24
01855 8X80	50 NR	0,26
01856 8X100	50 NR	0,37
01857 8X120	50 NR	0,48
09109 10x100	50 NR	0,62
09110 10x135	50 NR	0,74
09111 10x160	50 NR	1,01
09112 10x230	50 NR	2,16

Tassello Fischer Mod.TA M 



Ancorante in acciaio con marcatura CE Opzione 7 per calcestruzzo non fessurato

mod	UM	€
01959 6	50 NR	1,04
01963 8	50 NR	1,18
01951 10	25 NR	1,59
01955 12	20 NR	2,22

Tassello Fischer Mod.TA M-S



ancorante in acciaio con marcatura CE Opzione 7 per calcestruzzo non fessurato con vite TE cl.8.8



mod	UM	€
01962 6	50 NR	1,26
01966 8	50 NR	1,58
01954 10	25 NR	2,48
01958 12	20 NR	3,48

Tassello Fischer Mod.FSA-S



Ancorante passante in acciaio con vite TE e rosetta larga



mod	L	UM	€
06050 8/15S	69	50 NR	0,50
06051 8/40S	94	50 NR	0,57
06052 10/10S	70	20 NR	0,68
06053 10/35S	95	20 NR	0,77
06054 12/10S	81	20 NR	1,07
06055 12/50S	121	20 NR	1,23

Tassello Fischer Mod.TA M-O



Ancorante in acciaio con occhiolo cl. 8.8



mod	UM	€
01961 6	50 NR	1,86
01965 8	50 NR	2,20
01953 10	25 NR	3,13
01957 12	15 NR	5,13

Tassello Fischer Mod.FA



Ancorante passante in acciaio con dado esagonale cieco



mod	L	UM	€
01799 8X70	65	25 NR	3,22
01800 8X85	80	25 NR	4,76
01794 10X85	75	25 NR	5,03
01795 12X100	85	20 NR	6,51
01796 12X135	120	20 NR	8,48
01797 14X115	100	10 NR	11,87
01798 14X145	130	20 NR	14,82

Tassello Fischer Mod.TA M-G



Ancorante in acciaio con gancio stampato



mod	UM	€
01960 6	50 NR	1,90
01964 8	50 NR	2,29
01952 10	25 NR	3,39
01956 12	15 NR	6,16

Tassello Fischer Mod.FBN II



Ancorante in acciaio con marcatura CE Opzione 7 per calcestruzzo non fessurato



mod	UM	€
06421 6/5	100 NR	0,51
06422 6/10	100 NR	0,53
06423 6/30	100 NR	0,64
06424 8/5 II	100 NR	0,63
06425 8/10+23 II	50 NR	0,64
06426 8/50+63 II	50 NR	0,79
06428 10/10+23 II	50 NR	0,92
06429 10/50+58 II	20 NR	1,08
06431 12/10+35 II	20 NR	1,37
06432 12/50+65 II	20 NR	1,72
06434 16/25+45 II	10 NR	2,56
06435 16/50+70 II	10 NR	3,79

Tassello Fischer Mod.TA M-BP



Ancorante in acciaio con vite di sicurezza



mod	UM	€
05665 8	50 NR	3,45

Tassello Fischer Mod.TA M-T/S



Ancorante in acciaio con marcatura CE opzione 7 per calcestruzzo non fessurato con distanziale e vite TE cl.8.8



mod	UM	€
05661 6	50 NR	1,77
05662 8	50 NR	1,97
05663 10	25 NR	3,19
05664 12	20 NR	5,88

Tassello Fischer Mod.SLM



Ancorante in acciaio



mod	UM	€
01916 6	50 NR	1,00
01920 8	50 NR	1,34
01903 10	25 NR	2,11
01907 12	20 NR	3,16
01911 16	10 NR	5,90
01914 20	5 NR	22,93

Tassello Fischer Mod.TA M-OD



Ancorante in acciaio con distanziale e occhiolo diam.interno 14,5 mm.



mod	UM	€
05666 10	50 NR	4,32

Tassello Fischer Mod.SLM-V



Ancorante in acciaio con vite TE cl.8.8



mod	UM	€
01919 6	50 NR	1,33
01923 8	50 NR	1,66
01906 10	25 NR	2,87
01910 12	20 NR	4,25

Tassello Fischer Mod.PO



Ancorante in ottone con filettatura interna



mod	UM	€
01862 6X24	100 NR	0,39
01863 8X30	100 NR	0,48
01859 10X35	100 NR	0,77
01860 12X40	100 NR	1,46

Tassello Fischer Mod.SLM-G



Ancorante in acciaio con gancio forgiato



mod	UM	€
01917 6	50 NR	2,90
01921 8	50 NR	3,65
01904 10	25 NR	5,03

Articolo	Mod	UM	€
01908	12	10 NR	7,94
01912	16	5 NR	14,08

Tassello Fischer Mod.SLM-O



Ancorante in acciaio con occhio cl.8.8

Articolo	Mod	UM	€
01918	6	50 NR	2,46
01922	8	50 NR	3,47
01905	10	25 NR	4,60
01909	12	15 NR	6,36

Tassello Fischer Mod.GM



Ancorante in ghisa

Articolo	Mod	UM	€
01834	6	50 NR	2,06
01836	8	50 NR	2,38
01830	10	25 NR	3,67
01832	12	20 NR	6,02

Tassello Fischer Mod.GM-V



Ancorante in ghisa con vite TE cl.8.8

Articolo	Mod	UM	€
01835	6	50 NR	2,40
01837	8	50 NR	3,18
01831	10	25 NR	5,09
01833	12	20 NR	7,81

Mensola Mod.CPF



a scomparsa

Articolo	mm	UM	€
01779	10X100	20 NR	1,87
01784	10X150	20 NR	1,95
01781	12X80	20 NR	1,95
01780	14X120	20 NR	2,02
01783	14X145	20 NR	2,09
01785	14X170	20 NR	2,15

Pistola professionale



in metallo per ancoranti chimici per FIP C700 e FIS VT 380C

Articolo	UM	€
02026	1 NR	81,88

Miscelatore



per cartucce FIP C700

Articolo	UM	€
02024	12 NR	1,48

Pompetta ad aria



per FIP C235

Articolo	UM	€
02025	1 NR	45,10

Cartuccia Fischer T BOND



Ancorante chimico in poliestere ibrido senza stirene ml.300

Articolo	UM	€
08751	12 NR	11,83

Tassello Fischer Mod.FIS-HN



a calza per applicazioni su muratura forata

Articolo	Mod	UM	€
02015	16X85	20 NR	1,66
02016	18X85	20 NR	1,77
02018	20X85	20 NR	2,16

Tassello Fischer Mod.FIS-HK



a rete per applicazioni su muratura forata

Articolo	Mod	UM	€
05488	12X50	50 NR	0,45
02013	16X85	50 NR	0,53
02014	16X130	50 NR	0,73
02017	20X85	50 NR	0,64

Collare Fischer Mod.CPT

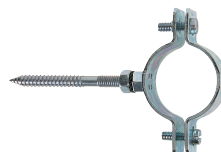

pesante per tubazioni in acciaio zincato per tubi da 3/8" a 4", completo di vite e tassello

Articolo	poll	UM	€
01792	3/8"	100 NR	1,04
01789	1/2"	100 NR	1,02
01791	3/4"	100 NR	1,02
01786	1	100 NR	1,04
01788	1.1/4"	50 NR	1,22
01787	1.1/2"	50 NR	1,30
01790	2"	50 NR	1,42

Collarino Fischer



in acciaio zincato per tubi

Articolo	mm	UM	€
01972	14	50 NR	0,39
01973	16	50 NR	0,39
01974	18	50 NR	0,40
01975	20	25 NR	0,41
01976	22	25 NR	0,42
01977	24	25 NR	0,45
01978	26	25 NR	0,46
01979	32	20 NR	0,49

Ancora Fischer KD4



Fissaggio versatile per supporti forati con dado ottone zigrinato taglio cacciavite

Articolo	UM	€
01846	50 NR	0,89

Ancora Fischer Mod.KDD4 

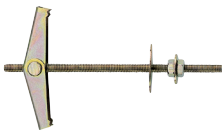

Fissaggio versatile per supporti forati con barra e 2 dadi

	01840		UM	€
		50	NR	0,88

Ancora Fischer Mod.KDH4 



Fissaggio versatile per supporti forati con occhio aperto

	01841		UM	€
		50	NR	0,84

Ancora Fischer Mod.KDV4 





Fissaggio versatile per supporti forati con vite taglio combinato

	01845		UM	€
		50	NR	0,77

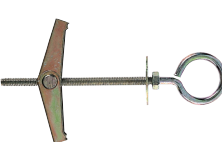
Ancora Fischer Mod.KDO4 



Fissaggio versatile per supporti forati con barra e occhio chiuso

	01844		UM	€
		50	NR	0,84

Ancora Fischer Mod.KD 

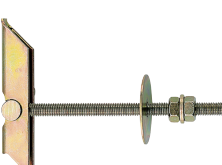



Fissaggio versatile per supporti forati con barra e 2 dadi

	mod		UM	€
01847	6	25	NR	1,31
01848	8	20	NR	3,49

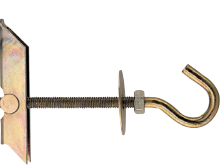
Ancora Fischer Mod.KDH 





Fissaggio versatile per supporti forati con occhio aperto

	mod		UM	€
01842	6	25	NR	1,40
01843	8	20	NR	4,55

Golfare Fischer Mod.GP50-TAM 





in acciaio per ponteggi con stelo esagonale, chiave da mm.22

	mod		UM	€
01838	12C	10	NR	10,59
01839	12L	10	NR	11,88

Tassello Fischer Mod.S-K 



in nylon blister

	mod	pz		UM	€
53788	5	35	20	BL	2,16
53789	6	30	20	BL	2,13
06593	8	20	20	BL	2,16
06594	10	10	20	BL	2,13

Tassello Fischer Mod.S4-GK 





in nylon appendiquadri con gancio ottonato in blister

	pz		UM	€
10433	10	10	NR	3,20

Tassello Fischer Mod.SX-SK 





in nylon con vite truciolare TPS con impronta pozidrive in blister

	mod	pz		UM	€
10434	5	20	20	NR	2,97
10435	6	15	15	NR	2,97
10436	8	10	10	NR	2,97

Tassello Fischer Mod.SV-K 



in nylon con vite truciolare TPS impronta pozidrive in blister

	mod	pz		UM	€
53793	5	20	1	BL	2,69
53794	6	15	20	BL	2,69
53795	8	10	20	BL	2,69
53796	10	4	20	BL	2,69

Tassello Fischer Mod.FUV-K 



in nylon con vite truciolare TPS impronta a croce in blister

	mod	pz		UM	€
53781	6X35	10	20	BL	3,42
53782	8X50	8	20	BL	3,42
53783	10X60	4	20	BL	3,42

Tassello Fischer Mod.N-K 





prolungati in nylon con vite a chiodo premontata blister

	mod	pz		UM	€
51306	6X80	15	20	BL	5,29
51307	8X80	10	20	BL	6,54

Tassello Fischer Mod.SB9-K 



in nylon con accessori in blister

	mod	pz		UM	€
53801	9/1	6	20	BL	2,87
53802	9/2	6	20	BL	2,87

Articolo	Mod.	pz	UM	€
53803	9/3	6	20 BL	2,87
53804	9/4	6	20 BL	2,87
53805	9/5	4	20 BL	2,89
53806	9/6	6	20 BL	2,89
53807	9/8	6	20 BL	2,87
05500	9/9	6	20 BL	2,89
53809	9/11	4	20 BL	2,89
53810	9/12	4	21 BL	2,89

Tassello Fischer Mod.SB12-K

in nylon con accessori in blister



Articolo	Mod.	pz	UM	€
53811	12/1	4	10 BL	2,97
53812	12/2	4	10 BL	2,93
53813	12/3	4	10 BL	2,93
53814	12/4	4	10 BL	2,97
53815	12/5	4	10 BL	2,97
53816	12/8	4	10 BL	2,93
05501	12/10	2	10 BL	2,97

Tassello Fischer Mod.SBS9-K

in acciaio con accessori in blister



Articolo	Mod.	pz	UM	€
53797	9/1	4	20 BL	2,97
53798	9/2	4	20 BL	2,97
53799	9/3	4	20 BL	2,97
53800	9/4	4	20 BL	2,97
53818	9/5	4	20 BL	2,97
53819	9/8	4	20 BL	2,97

Tassello Fischer Mod.SLM TE-K

in acciaio con vite TE classe 8.8 in blister



Articolo	Mod.	pz	UM	€
51314	6	2	20 BL	4,12
51315	8	2	20 BL	5,45
51316	10	2	20 BL	7,85

Tassello Fischer Mod.TAM-GK

in acciaio con con gancio in blister



Articolo	Mod.	pz	UM	€
05506	6	2	20 BL	4,49
05507	8	2	20 BL	5,81

Tassello Fischer Mod.TAM-OK

in acciaio con occhio classe 8.8 in blister



Articolo	Mod.	pz	UM	€
05504	6	2	20 BL	4,49
05505	8	2	20 BL	5,81

Tassello Fischer Mod.TAM-SK

in acciaio con vite TE classe 8.8 con marcatura CE opzione 7 per calcestruzzo non fessurato in blister



Articolo	Mod.	pz	UM	€
05502	6	4	20 BL	6,16
05503	8	4	20 BL	7,89

Ancora Fischer Mod.KD-K

in acciaio in blister



Articolo	Mod.	pz	UM	€
05508	KD	2	20 BL	2,73
05509	KDH	2	20 BL	2,73

Tassello Fischer Mod.PFM-K

per mensole a scomparsa CPF in blister



Articolo	Mod.	pz	UM	€
05673	8	4	20 BL	2,48
05674	10	4	20 BL	2,95

Tassello Fischer Mod.W100SK

in nylon con vite truciolare TPS impronta pozidrive e punta in blister



Articolo	Mod.	PZ	UM	€
01968	5	16	20 BL	4,41
01969	6	10	20 BL	4,41
01970	8	6	20 BL	4,41
01967	10	4	20 BL	4,41

Tassello Fischer mod.N4-35K



in nylon con vite per battiscopa in blister

mod	pz	UM	€
51304 4X35	25	20 BL	5,15

MM.	UM	€
92492 8X50	50 NR	0,18
92493 10X60	40 NR	0,28

Tassello legno



in conf.pz.100 in blister

COD	MM	UM	€
03186 655,00	6X30	10 NR	2,53
03187 660,00	8X35	10 NR	2,20
03188 665,00	10X40	10 NR	2,31

in nylon con collarino



mm	UM	€
92482 6X30	100 NR	0,03
92483 8X40	100 NR	0,06
92484 10X50	50 NR	0,10

in nylon



mod	mm	UM	€
88385 115	4	200 NR	0,02
88386 101	5	200 NR	0,02
88387 103	6	100 NR	0,02
88388 105	8	100 NR	0,03
88389 107	10	50 NR	0,06
88390 109	12	25 NR	0,11

in nylon con collarino vite TPS pozidrive



mm	UM	€
92485 6X30	100 NR	0,07
92486 8X40	100 NR	0,14
92487 10X50	50 NR	0,20

in nylon prolungati con vite TPS



mod	mm	UM	€
88449 101	6X60	100 NR	0,14
88450 104	8X60	50 NR	0,29
88451 102	8X80	50 NR	0,32
88452 105	10X80	50 NR	0,45
88453 103	10X100	50 NR	0,50
88454 106	10X115	50 NR	0,68
88455 107	10X135	50 NR	0,81
88456 108	10X160	50 NR	1,00

in nylon con vite TPS pozidrive



mod	mm	UM	€
88392 101	5	100 NR	0,05
88393 103	6	100 NR	0,06
88394 105	8	100 NR	0,08
88395 107	10	50 NR	0,17

in nylon prolungati con vite TORX



mm	UM	€
95068 8x80	50 NR	0,36
95069 8x100	50 NR	0,44
95070 8x120	50 NR	0,53
95071 10x80	50 NR	0,51
95072 10x100	50 NR	0,58
95073 10x120	50 NR	0,67
95074 10x140	50 NR	0,75
95075 10x160	50 NR	0,90
95076 10x200	50 NR	1,47
95077 10x240	50 NR	3,30

in nylon con collarino



mod	mm	UM	€
88400 202	5	1000 NR	0,02
88401 204	6	1000 NR	0,01
88402 206	8	500 NR	0,03
09611 206	8	1000 NR	0,02
88403 208	10	250 NR	0,05

in nylon a trazione con collarino e vite TPS pozidrive



mod	mm	UM	€
88411 101	6X35	100 NR	0,08
88413 102	8X50	50 NR	0,15
88414 103	10X60	40 NR	0,23

in nylon prolungati con vite chiodo premontata



mod	mm	UM	€
88457 101	4X35	100 NR	0,08
88458 102	5X50	100 NR	0,12
88459 103	6X40	100 NR	0,12
88460 104	6X60	100 NR	0,14
88461 105	6X80	100 NR	0,18
88462 106	8X60	100 NR	0,21
88463 107	8X80	100 NR	0,21
88465 109	8X120	100 NR	0,37
88464 108	8X100	100 NR	0,30

in nylon a trazione con collarino e vite TPS pozidrive



mm	UM	€
92491 6X40	100 NR	0,10

mm.6x37



mod	UM	€
08714 s/vite	250 NR	0,13
10446 c/vite 4x30 mm	250 NR	0,22



Ancorante HAV in nylon 6 è un fissaggio non passante indicato per applicazioni leggere su pareti vuote e lastre. Indicato per applicazioni in edilizia sia su materiali compatti che forati.

mod	mm	vite	UM	€
94469	10	4x50	100 NR	0,19
94470	17	4x60	100 NR	0,22



Tassello in lega di zamak non passante con speciale sagoma geometrica ad elica, adatto per pareti in cartongesso, calcestruzzo cellulare etc. Da utilizzare con viti truciolari

mis	UM	€
94471 6x37	250 NR	0,20



Tassello in lega di zamak non passante con speciale sagoma geometrica ad elica, adatto per pareti in cartongesso, calcestruzzo cellulare etc. con vite

mis	UM	€
94472 4,4x40	200 NR	0,30



in nylon occhio aperto

mod	mm	UM	€
88415 104 9	100 NR	0,26	
88426 113 12	100 NR	0,30	



in nylon gancio medio

mod	mm	UM	€
88416 102 9	100 NR	0,24	
88427 111 12	100 NR	0,29	



in nylon occhio chiuso

mod	mm	UM	€
88417 105 9	100 NR	0,27	
88428 114 12	100 NR	0,31	



in nylon con vite TSC

mod	mm	UM	€
88418 106 9	100 NR	0,21	
88429 115 12	100 NR	0,24	



in nylon con vite doppia

mod	mm	UM	€
88419 107 9	100 NR	0,41	
88430 116 12	100 NR	0,51	



in nylon gancio lungo

mod	mm	UM	€
88420 103 9	100 NR	0,26	
88431 112 12	100 NR	0,30	



in nylon gancio corto

mod	mm	UM	€
88421 101 9	100 NR	0,24	
88432 110 12	100 NR	0,29	



in nylon fermaporte

col	mm	UM	€
88422 bianco 9	20 NR	0,70	
88423 nero 9	20 NR	0,70	



in nylon prolungati con vite TSC

mod	mm	UM	€
88424 106 9	100 NR	0,32	



in nylon prolungati gancio corto

mod	mm	UM	€
88425 101 9	100 NR	0,33	



in acciaio zincato occhio aperto

mod	mm	UM	€
88436 114 8	100 NR	0,24	
88442 104 9	100 NR	0,31	



in acciaio zincato gancio medio

mod	mm	UM	€
88437 112 8	100 NR	0,22	
88443 102 9	100 NR	0,28	



in acciaio zincato occhio chiuso

mod	mm	UM	€
88438	115	8 100 NR	0,25
88444	105	9 100 NR	0,32



in acciaio zincato con vite TSC

art	MM	UM	€
88439	116	8 100 NR	0,18
88445	106	9 100 NR	0,27



in acciaio zincato con vite doppia

mod	mm	UM	€
88440	117	8 100 NR	0,38
88446	107	9 100 NR	0,51



in acciaio zincato gancio corto

mod	mm	UM	€
88441	111	8 100 NR	0,21
88448	101	9 100 NR	0,29



in acciaio zincato gancio lungo

mod	mm	UM	€
88447	103	9 100 NR	0,33

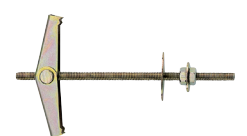

in acciaio zincato doppio dado

mod	mm	UM	€
88467	103	4X100 100 NR	0,42

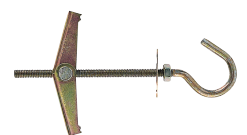

in acciaio zincato occhio aperto

mod	mm	UM	€
88468	102	4X95 100 NR	0,42

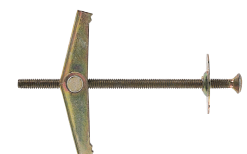

in acciaio zincato con vite TSC

mod	mm	UM	€
88469	104	4X95 100 NR	0,42

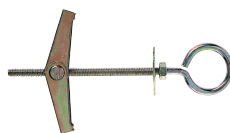

in acciaio zincato occhio chiuso

mod	mm	UM	€
88470	101	4X95 100 NR	0,42

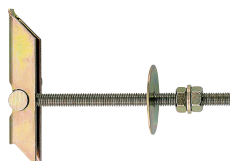

in acciaio zincato doppio dado

mod	mm	UM	€
88471	113	6X100 50 NR	0,74

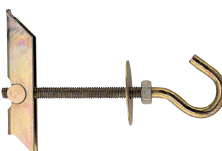

in acciaio zincato occhio aperto

mod	mm	UM	€
88472	112	6X100 50 NR	0,74

Occhio chiuso



filettato per fissaggi chimici

mis	UM	€
92496 6x55	100 NR	0,42
92497 8x65	50 NR	0,55
92498 10x73	50 NR	0,98



filettata per fissaggi chimici

mis	UM	€
92500 8x100	50 NR	0,71
92501 10x110	50 NR	0,92
92502 12x110	25 NR	1,43
92503 16x140	10 NR	2,24



Ancorante chimico POLIESTERE ad iniezione in resina poliesterre bicomponente senza STIRENE, non necessita di premiscelazione, la resina e l'indurente si miscelano solo durante l'estrusione, cartucce riutilizzabili in tempi successivi. Cartuccia da ml.300 CE

UM	€
91426 15 NR	7,51



Ancorante chimico POLIESTERE ad iniezione in resina poliesterre bicomponente senza STIRENE, non necessita di premiscelazione, la resina e l'indurente si miscelano solo durante l'estrusione, cartucce riutilizzabili in tempi successivi. Cartuccia da ml.400

Icona	mod	mm	UM	€
	91427		12 NR	7,75



Ancorante chimico VINILESTERE ad iniezione in resina vinilestrere bicomponente senza STIRENE, ancorante ad alto valore di aderenza anche in presenza di acqua, su materiali compatti (calcestruzzo, roccia, muri pieni); indicati anche per materiali forati utilizzando l'apposita gabbiotta.

Icona	ml	UM	€
	92750 300	15 NR	8,83
	88652 380	12 NR	9,99

Beccuccio



per cartucce bicomponenti

Icona	UM	€
	07361 10 NR	0,38

Tassello iniezione



a rete mm.15x85

Icona	UM	€
	91123 1 CF	26,04

Pompetta ad aria



per pulizia fori

Icona	UM	€
	92833 1 NR	19,98

Pistola per Cartucce Bicomponenti



coassiale lunghezza mm.195, capacità MI.380 per codice 88652-91427

Icona	UM	€
	87890 1 NR	37,04

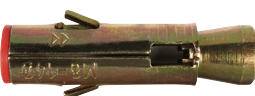

ancorante in acciaio con alette antirotazione solo corpo

Icona	mod	mm	UM	€
	90002 6	6x45	100 NR	0,86
	90003 8	8x55	50 NR	0,98
	90004 10	10x65	50 NR	1,22
	90005 12	12x75	40 NR	1,59
	90006 16	16x90	25 NR	4,54



ancorante in acciaio con alette antirotazione con vite T.E.

Icona	mod	mm	UM	€
	90007 6	6x50x40	100 NR	1,08
	90008 8	8x70	50 NR	1,38
	90009 10	10x80	40 NR	1,81
	90010 12	12x100	25 NR	2,59
	90011 16	16x100	15 NR	6,69



ancorante in acciaio con alette antirotazione con barra filettata

Icona	mod	mm	UM	€
	90012 6	6x60	100 NR	1,12
	90013 8	8x70	50 NR	1,31
	90014 10	10x85	40 NR	1,74
	90015 12	12x110	25 NR	2,56



ancorante in acciaio con alette antirotazione con occhiolo

Icona	mod	mm	UM	€
	90016 6	6x45	100 NR	1,35
	90017 8	8x55	50 NR	1,63
	90018 10	10x65	25 NR	2,26
	90019 12	12x75	25 NR	3,45
	90020 16	16x90	15 NR	10,24

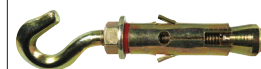

ancorante in acciaio con alette antirotazione con gancio

Icona	mod	mm	UM	€
	90021 6	6x45	100 NR	1,38
	90022 8	8x55	50 NR	1,68
	90023 10	10x65	25 NR	2,33
	90024 12	12x75	25 NR	3,63
	90025 16	16x90	15 NR	10,81



ancorante in acciaio a settori con cono antirotazione solo corpo

Icona	mod	mm	UM	€
	90026 6	10x45	100 NR	0,57
	90027 8	12x50	100 NR	0,66
	90028 10	14x60	50 NR	0,85
	90029 12	18x75	50 NR	1,28



ancorante in acciaio a settori con cono antirotazione con vite T.E.

Icona	mod	mm	UM	€
	90030 6	6x55	100 NR	0,84
	90031 8	8x60	50 NR	1,10
	90032 10	10x70	40 NR	1,53
	90033 12	12x100	25 NR	2,54



ancorante in acciaio a settori con cono antirotazione con occhio

mod	mm	UM	€
90037	6 6x45	100 NR	1,15
90038	8 8x50	50 NR	1,45
90039	10 10x60	25 NR	2,04



ancorante in acciaio a settori con cono antirotazione con vite e distanziale

mod	mm	UM	€
90034	6 6x45	50 NR	1,33
90035	8 8x50	25 NR	1,56
90036	10 10x60	25 NR	2,06



ancorante in acciaio con diametro ridotto di foratura a grande espansione meccanica con dado cieco

mod	mm	UM	€
90048	8/70 8x70	50 NR	2,77
90049	8/85 8x85	50 NR	3,53
90050	10/85 10x85	50 NR	3,75
90051	10/120 10x120	50 NR	4,78
90052	12/100 12x100	50 NR	5,00
90053	12/135 12x135	50 NR	6,76



ancorante in acciaio solo corpo a quattro settori e cono di espansione

mod	mm	UM	€
90040	6 10x45	100 NR	0,96
90041	8 14x50	100 NR	1,28
90042	10 16x60	50 NR	1,83
90043	12 20x80	50 NR	3,45



ancorante in acciaio a quattro settori con cono di espansione con vite T.E.

mod	mm	UM	€
90044	6 6x50x40	100 NR	1,26
90045	8 8x60x50	50 NR	1,82
90046	10 10x70x50	40 NR	2,60
90047	12 12x100x80	25 NR	4,58



ancorante in acciaio torniti per fissaggi passanti, con profondità di inserimento variabile con dado

mod	mm	UM	€
90054	6/15 6x65	100 NR	0,26
90055	8/5 8x50	100 NR	0,30
90056	8/20 8x75	100 NR	0,36
90057	8/60 8x115	100 NR	0,48
90058	10/5 10x75	50 NR	0,44
90059	10/20 10x95	50 NR	0,45
90060	10/50 10x120	50 NR	0,56
90143	12/10 12x95	50 NR	0,66
90061	12/30 12x110	50 NR	0,68
90062	12/60 12x145	50 NR	0,88
90063	16/30 16x145	25 NR	1,64
90064	16/55 16x175	25 NR	2,25



Ancorante in acciaio omologato ETA con marcatura CE Opzione 7 per calcestruzzo non fessurato

mm	UM	€
95058 8X80	100 NR	0,44
95059 8X120	100 NR	0,59
95060 10X90	50 NR	0,61
95061 10X100	50 NR	0,72
95062 10X120	50 NR	0,77
95063 12X100	25 NR	0,94
95064 12X120	50 NR	1,08
95065 12X140	50 NR	1,24
95066 16X150	25 NR	2,16
95067 16X175	25 NR	2,65



ancorante in acciaio inox A4 AISI 316 stampati a freddo, con singola fascetta di espansione con dado

mod	mm	UM	€
90072 8/10 8x75	50 NR	2,79	
90073 10/30 10x100	50 NR	5,44	
90074 12/20 12x100	25 NR	7,21	



ancorante in acciaio a tre settori costituiti da un corpo in lamiera stampata, cono espansore e vite in acciaio T.E. 6x8. L'anello in plastica rosso serve come compensazione automatica di cavità.

mod	mm	UM	€
90075 8/2 6x45	200 NR	0,27	
90076 8/5 6x60	200 NR	0,31	
90077 10/2 8x60	100 NR	0,42	
90078 10/20 8x80	100 NR	0,56	
90079 12/20 10x70	50 NR	0,65	
90080 12/50 10x100	50 NR	0,81	



a scomparsa

mm	UM	€
88479 8x70	30 NR	1,87
88475 12X80	30 NR	1,91
88473 10X100	30 NR	1,77
88476 14X120	30 NR	1,96
88477 14X145	30 NR	2,08
88474 10X150	30 NR	1,88
88478 14X170	30 NR	2,18



ancorante in acciaio speciale per ponteggi con golfare diam.mm.51 per il passaggio del tubo del ponteggio all'interno del golfare stesso. Conforme alle normative europee vigenti

mod	mm	UM	€
90085 51 12x130	10 NR	5,03	
90086 51 12x180	10 NR	7,98	



ancorante per ponteggi

mod	mm	UM	€
90081 golfare 24 14x120	25 NR	2,70	

mod	mm	UM	€
90082 golfare 24	16x140	20 NR	3,65
92541 golfare 51	14x120	50 NR	5,40
92542 golfare 51	16x140	40 NR	6,03
90083 corpo nylon	14x100	25 NR	0,29
92543 corpo nylon	16x140	20 NR	0,66
90084 tappo		100 NR	0,11

Tassello per cappotto ISO



in polipropilene additivato a battuta di tipo passante

Spess	UM	€
10779 30-40	500 NR	0,14
10780 40-50	500 NR	0,15
10781 70-80	500 NR	0,18
10782 90-100	250 NR	0,22
10783 110-120	250 NR	0,47
10784 130-140	250 NR	0,54

Tassello in nylon N-PL 60



per materiali isolanti. ancorante di tipo non passante idoneo per il fissaggio su pannelli in polistirene, polistirolo, polistirene estruso, termoisolanti e termoacustici rigidi e per applicazioni sui sistemi ETICS. La particolare geometria a spirale elicoidale permette un'aderenza totale nei materiali di posa, facilità e velocità nell'installazione. Possibilità di rimozione dell'oggetto fissato per operazioni di manutenzione senza inficiare la tenuta dell'ancorante. La doppia impronta del collarino stellare, superficie interna al collarino permette l'alloggiamento dell'inserto per una posa in opera precisa nel materiale di supporto.

lungh.	diam.mm.	UM	€
16623 58	25	25 NR	1,06

Tassello in nylon N-PL 95



per materiali isolanti. ancorante di tipo non passante idoneo per il fissaggio su pannelli in polistirene, polistirolo, polistirene estruso, termoisolanti e termoacustici rigidi e per applicazioni sui sistemi ETICS. La particolare geometria a spirale elicoidale permette un'aderenza totale nei materiali di posa, facilità e velocità nell'installazione. Possibilità di rimozione dell'oggetto fissato per operazioni di manutenzione senza inficiare la tenuta dell'ancorante. Le ali interne al copo guidano e permettono il serraggio preciso della vite mentre l'alloggiamento esagonale del collarino consente l'inserimento dell'inserto per l'operazione di installazione.

lungh.	diam.mm.	UM	€
16624 65	32	20 NR	1,64



in nylon con vite in blister

mis	pz.	UM	€
93006 5x25	20	1 BL	2,29
93007 6x30	15	1 BL	2,21
93008 8x40	10	1 BL	2,29



in nylon con collarino e vite in blister

mis	pz.	UM	€
93035 6x30	15	1 BL	2,33
93036 8x40	10	1 BL	2,49
93037 6x30	6	1 BL	2,56



in nylon con collarino e vite in blister

mis	pz.	UM	€
93030 5x25	20	1 BL	2,29
93031 6x30	15	1 BL	2,21
93032 8x40	10	1 BL	2,29



in nylon a trazione con collarino e vite in blister

mis	pz.	UM	€
93021 6x40	10	1 BL	2,25
93022 8x50	10	1 BL	2,76
93023 10x60	6	1 BL	3,18



in nylon con gancio per quadri in blister

mis	pz.	UM	€
93009 4x20	30	1 BL	4,04



in nylon mini mm.6x25 in blister

mod	UM	€
93024 vite	1 BL	3,61
93025 gancio corto	1 BL	3,84
93026 occhio	1 BL	4,16



in nylon gancio corto in blister

mis	pz.	UM	€
93017 9x38	6	1 BL	3,22



in nylon gancio medio in blister

mis	pz.	UM	€
93018 9x38	6	1 BL	3,30



in nylon occhio aperto in blister

mis	pz.	UM	€
93019 9x38	6	1 BL	3,69



in nylon occhio chiuso in blister

mis	pz.	UM	€
93020 9x38	6	1 BL	3,69



in acciaio con bullone in blister

mis	pz.	UM	€
93027 8x60	2	1 BL	4,19



in acciaio mini mm.6x25

mod	UM	€
93010 vite	1 BL	3,65
93011 gancio corto	1 BL	3,84
93012 occhio	1 BL	3,84



in nylon prolungato con vite in blister

mis	pz.	UM	€
93033 4x30	14	1 BL	5,16
93034 6x45	20	1 BL	3,69
93028 6x60	15	1 BL	3,53
93029 6x80	15	1 BL	4,08

Ancorina in acciaio



in Blister pz.2

mod	UM	€
93013 MDW 104 A	1 BL	2,45
93014 MDD 103 B	1 BL	2,49
93015 MDO 101 C	1 BL	2,45
93016 MDH 102 D	1 BL	2,41

Espositore VUOTO



24 ganci per tasselli Maurer blister

	UM	€
93038 Espo vuoto	1 NR	66,00
12549 assortimento base	1 NR	333,60

Cerniera Mod.100



2 ali perno sfilabile

mm	UM	€
09804 60	48 NR	0,50
09805 80	48 NR	0,58

MM	UM	€
09806 100	24 NR	0,74
09807 120	24 NR	0,95
09808 140	24 NR	1,20
09809 140P	12 NR	1,59
09810 170P	12 NR	2,03
09811 200P	12 NR	2,50

Cerniera Mod.105



3 ali perno sfilabile

mm	UM	€
09812 80	48 NR	0,70
09813 100	24 NR	0,86
09814 120	24 NR	1,09
09815 140	24 NR	1,28
09816 140P	12 NR	1,69
09817 170P	12 NR	2,35
09818 200P	12 NR	2,83

Cerniera Mod.110



a tappo 2 ali perno fisso

mm	UM	€
09819 60	48 NR	0,77
09820 80	48 NR	0,92
09821 100	24 NR	1,00
09822 120	24 NR	1,39
09823 140	24 NR	1,65
09824 170P	12 NR	2,73

Cerniera Mod.115



per cancelli 2 ali aperte con rondella ottone

mm	UM	€
09825 90	8 NR	4,70

Cerniera Mod.130



per cancelli 3 ali aperte con cuscinetti

mm	UM	€
09826 180	4 NR	11,01

Cerniera Mod.135



per cancelli 4 ali aperte con rondella ottone

mm	UM	€
09827 180	4 NR	9,10

Cerniera Mod.140

per cancelli 4 ali aperte con cuscinetti

mm	UM	€
09828 180	4 NR	13,60

Cerniera Mod.262

profilo a goccia perno ottone sfilabile con cuscinetto

mm	UM	€
09874 20X25X150	18 NR	4,63

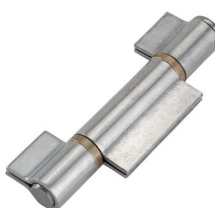
Cerniera Mod.155

per cancelli 3 ali aperte con rondella ottone

mm	UM	€
09829 180	6 NR	7,97

Catenaccio Mod.205

verticale 10x10 zincato

mm	UM	€
09830 130	10 NR	4,16
09831 300	10 NR	5,86
09832 500	10 NR	7,84

Cerniera Mod.255

con costa perno acciaio zincato rondella fissa

mm	UM	€
09862 60	48 NR	0,64
09863 80	48 NR	0,94
09864 100	24 NR	1,19
09865 120	24 NR	1,61
09866 140	24 NR	1,80

Catenaccio Mod.215

verticale 6x16 zincato

mm	UM	€
09833 200	10 NR	3,41
09834 300	10 NR	3,89

Cerniera Mod.255

con costa perno acciaio zincato e rondella ottone sfilabile

mm	UM	€
09867 20X140	18 NR	3,07

Catenaccio Mod.216

verticale 6x16 con fori zincato

mm	UM	€
09835 200	10 NR	3,61
09836 300	10 NR	4,33

Cerniera Mod.256

con costa perno e rondella ottone

mm	UM	€
09868 60	48 NR	0,95
09869 80	48 NR	1,34
09870 100	24 NR	1,69
09871 120	24 NR	2,28
09872 140	24 NR	2,56
09957 20X140	18 NR	3,65

Catenaccio Mod.220

verticale 10x25 zincato pesante

mm	UM	€
09837 200	10 NR	6,10
09838 300	10 NR	7,43
09839 400	10 NR	9,13
09840 500	10 NR	11,18

Cerniera Mod.261

profilo a goccia perno ottone con cuscinetto

mm	UM	€
09873 20X25X150	18 NR	5,59

Catenaccio Mod.221

doppia azione zincato con leva ottone

mm	UM	€
09841 24	10 NR	10,43

Catenaccio Mod.223 

azione semplice zincato con leva ottone



mm	UM	€
09842 20	10 NR	6,82
09843 24	10 NR	6,82

Chiavistello Mod.225 

pesante zincato a saldare



UM	€
09844 50 NR	3,14

Catenaccio Mod.284 

portalucchetto zincato



mm	UM	€
09880 180	10 NR	5,25
09881 250	10 NR	5,96

Chiavistello Mod.232 

a scatto zincato per sportelli



mod	UM	€
09847 piccolo	20 NR	5,45
09848 grande	20 NR	6,82

Catenaccio Mod. 287 

portalucchetto zincato



mm	UM	€
09882 180	6 NR	6,82
09883 220	6 NR	7,97
09884 270	6 NR	10,50

Cricchetto Mod.265 

per sopra luce medio



UM	€
10515 20 NR	1,77

Cricchetto Mod.266 

per sopra luce grande



UM	€
10516 25 NR	3,97

Catenaccio Mod.288 

portalucchetto con asta tonda tropicalizzato



mm	UM	€
09885 150	10 NR	8,04
09886 200	10 NR	9,68

Chiave Mod.233 

per chiavistello a scatto



UM	€
09849 20 NR	2,28

Catenaccio Mod.289 

verticale con asta tonda zincato



mm	UM	€
09887 200	12 NR	4,43
09888 300	12 NR	5,56

Tavellino Mod.230 

zincato per sportelli



UM	€
09845 50 NR	2,90

Catenaccio Mod.291 

trasversale verniciato marrone

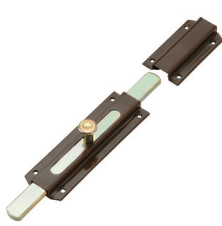

mm	UM	€
09889 70	12 NR	3,58
09890 120	12 NR	4,16
09891 150	12 NR	4,63
09892 200	12 NR	4,91

Cerniera Mod.275 

wasistas



mm	UM	€
09875 65	20 NR	1,64
09876 85	20 NR	2,14

Chiave Mod.231 

per tavellino quadra



 09846	 50	UM NR	€ 1,44
---	--	----------	-----------

Cariglione Mod.385 

quadro 10 verniciato nero





 09922	 6	UM NR	€ 18,57
---	---	----------	------------

Maniglia Mod.280 

a blocco zincata



 mod	 12	UM NR	€ 3,58
09877 DX			
09878 SX	12	NR	3,58

Cariglione Mod.390 

quadro 14 zincato senza cilindro





 09923	 5	UM NR	€ 28,29
---	---	----------	------------

Maniglia Mod.281 

a blocco zincata ambidestra



 09879	 12	UM NR	€ 4,67
---	--	----------	-----------

Cariglione Mod.391 

quadro 14 zincato con cilindro



 09924	 5	UM NR	€ 42,94
---	---	----------	------------

Maniglione Mod.360 

diritto verniciato nero





 mm	 10	UM NR	€ 10,39
09915 230			

Ruota Mod.402 

gola V 1 cuscinetto



 mm	 12	UM NR	€ 8,52
09925 60			
09926 80	6	NR	11,08
09927 90	6	NR	12,61
09928 100	6	NR	13,80
09929 120	4	NR	17,89
09930 140	4	NR	23,86

Maniglione Mod.361 

curvato verniciato nero





 mm	 10	UM NR	€ 10,91
09916 230			

Ruota Mod.405 

gola tonda 2 cuscinetti



 mm	 6	UM NR	€ 25,39
09931 120			
09932 140	4	NR	35,78
09933 160	2	NR	48,05
09934 200	2	NR	66,29

Cardine Mod.370 

regolabile grezzo



 mod	 12	UM NR	€ 11,59
09917 piccolo			
09918 grande	10	NR	13,19

Ruota Mod.407 

gola V 2 cuscinetti



 mm	 6	UM NR	€ 25,39
09935 120			
09936 140	4	NR	35,78
09937 160	2	NR	48,05
09938 200	2	NR	66,29

Ruota Mod.412

gola V 1 cuscinetto supporto cavallotto

mm	UM	€
09939 80	6 NR	15,00

Oliva Mod.448

nylon bombata

mm	UM	€
09947 35X30	10 NR	3,58

Ruota Mod.425

tonda 1 cuscinetto supporto interno

mm	UM	€
09940 100	6 NR	16,53
09941 120	6 NR	21,30
09942 140	4 NR	28,63

Cardine Mod.345

regolabile zincato con cuscinetto

diam mm	UM	€
09904 45	4 NR	22,63

Ruota Mod.427

gola V 1 cuscinetto supporto interno

mm	UM	€
09943 90	6 NR	15,17
09944 100	6 NR	16,53
09945 120	6 NR	21,30
09946 140	4 NR	28,63

Oliva Mod.450

oliva nylon

mm	UM	€
09948 25X30 M14	20 NR	3,41
09949 30X40 M14	8 NR	3,75
09950 40X60 M16	14 NR	5,45

Arresto Mod.381

fine corsa zincato

mod	UM	€
09920 piccolo	10 NR	5,28
09921 grande	10 NR	6,65

Cardine Mod.345R

regolabile zincato con cuscinetto con viti di registro

diam mm	UM	€
09905 70	4 NR	28,54

Battente Mod.380

battente d'arresto zincato

	UM	€
09919	16 NR	4,26

Cardine Mod.875Z

regolabile zincato con ali

mis	UM	€
09952 M18	12 NR	8,18
09953 M22	6 NR	10,39

Maniglia Mod.355

con vite in testa verniciata nera

mm	UM	€
09913 25/35	20 NR	4,42
09914 40/50	20 NR	4,42

Cardine Mod.876Z

zincato con ali boccola a saldare

mis	UM	€
09954 M18	12 NR	5,96
09955 M22	6 NR	7,50

Piastra Mod.462



guida regolabile 4 olive mm.30x40 in nylon



09951



6 UM

NR

€ 29,82

Piastra Mod.346



girevole zincata con cuscinetto reggispinta con ingrassatore



09906

diam mm 45



4 UM

NR

€ 18,75

09907

70



4 UM

NR

€ 25,69

Perno Mod.347

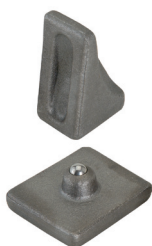

inferiore con piastra sferica



09908



6 UM

NR

€ 14,76

Paletto Mod.305



a leva per cancelli zincato



09893

mm 450



10 UM

NR

€ 4,26

Perno Mod.348



sferico inferiore grezzo



09909

diam. 20



10 UM

NR

€ 2,35

09910

24



6 UM

NR

€ 3,28

Paletto Mod.310



a leva pesante per cancelli zincato



09894

mm 500



10 UM

NR

€ 7,36

Copripilastro Mod.340



quadro



09895

mm 30



100 UM

NR

€ 0,53

09896

40



100 UM

NR

€ 0,56

09897

50



100 UM

NR

€ 0,59

09898

60



80 UM

NR

€ 0,65

09899

80



50 UM

NR

€ 0,95

09900

100



40 UM

NR

€ 1,36

09901

120



50 UM

NR

€ 1,79

09903

150



30 UM

NR

€ 3,13

Piastra Mod.349

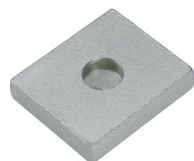

per perno sferico inferiore grezza



09911

diam mm 20



10 UM

NR

€ 2,10

09912

24



6 UM

NR

€ 3,05

Fisce Mod.240



ala media



09850

mm 60

DX



20 UM

NR

€ 1,15

09852

80

DX



20 UM

NR

€ 1,21

09854

100

DX



20 UM

NR

€ 1,72

09856

120

DX



20 UM

NR

€ 2,01

09858

140

DX



16 UM

NR

€ 2,62

09860

160

DX



16 UM

NR

€ 2,99

09851

60

SX



20 UM

NR

€ 1,15

09853

80

SX



20 UM

NR

€ 1,21

09855

100

SX



20 UM

NR

€ 1,72

09857

120

SX



20 UM

NR

€ 2,01

09859

140

SX



16 UM

NR

€ 2,62

09861

160

SX



16 UM

NR

€ 2,99

Custodia per avvolgibile

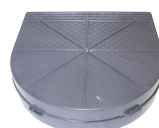

in plastica mm.185



09121



10 UM

NR

€ 2,31

Avvolgitore



zincato incas.interasse 185



09122

mt 4



50 UM

NR

€ 3,95

09124

6



50 UM

NR

€ 4,12

09125

8



50 UM

NR

€ 4,49

09126

12



25 UM

NR

€ 7,85

12936

placca cromata



1 UM

NR

€ 1,00

Avvolgitore



zincato incas.interasse 165



09123

mt 6



50 UM

NR

€ 3,76

Forcella per avvolgitore



per rullo legno

12937

5 UM NR € 0,95

Calotta per avvolgitore



ottagonale con perno tipo fisso

12938

1 UM NR € 0,96

Puleggia



per rullo tapparelle in legno mm.220

12942

20 UM NR € 3,61

Puleggia



per rullo ottagonale mm.220

12943

15 UM NR € 3,91

Calotta per avvolgitore



ottagonale tipo regolabile

12939

50 UM NR € 5,72

Riduttore per rullo



per rulli ferro foro ottagonale

12940

1 UM NR € 30,61

Riduttore per rullo



per rulli legno

12941

7 UM NR € 30,61

Supporto per riduttore



pesante completo

12951

5 UM NR € 3,17

Supporto per riduttore



a murare leggero senza zanca

12952

100 UM NR € 1,36

Cuscinetto leggero



senza zanca

12953

200 UM NR € 0,90

Rullo ottagonale



per tapparelle in ferro zincato mm.60

12954 1,60
12955 2,20

10 UM NR € 6,62
10 UM NR € 9,11

Gancio fisso per avvolgibile



tipo "U" mm.42

12950

250 UM NR € 0,11

Gancio fissaggio



per tapparelle per rullo ottagonale

12948

150 UM NR € 0,25

Gancio per rullo legno



iniziale a 1 feritoia

12949

500 UM NR € 0,14

Guida cinghia per cintino



con rulli in nylon

12944

50 UM NR € 0,35

Guida cinghia per cintino



con rulli nylon trasversali

 12945	 50	UM NR	€ 0,39
---	--	-------	--------

Tappo conico



d'arresto mm.40 colore grigio

 12946	 100	UM NR	€ 0,21
---	---	-------	--------

Tappo conico



d'arresto mm.40 colore marrone

 12947	M	 1	UM NR	€ 0,22
---	---	---	-------	--------

Fermapersiane omino nero



con vite e tassello

 14338	 25	UM NR	€ 2,40
---	--	-------	--------

Fermapersiane omino nero



con fermo vite e tassello

 14339	 25	UM NR	€ 2,94
---	--	-------	--------

Fermapersiane omino nero







fermo regolabile con vite e tassello

 14340	 40	UM NR	€ 3,90
---	--	-------	--------

Maniglia Americana



per bauli, plastificata nera

 14341	9 cm	 12	UM NR	€ 1,10
 14342	11 cm	 12	UM NR	€ 1,32

Maniglia stampata nera



 14343	135 mm	 10	UM NR	€ 0,89
---	--------	--	-------	--------

Cerniere mod.741





per serie 700 in acciaio tropicalizzato

 13457	98x98 mm	 10	UM NR	€ 4,98
---	----------	--	-------	--------

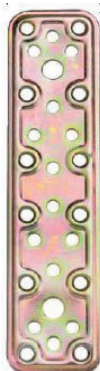
Giunzione Mod. 745







diritta in acciaio tropicalizzato

 13458	40x80 mm	 50	UM NR	€ 0,59
 13459	40x160 mm	 25	UM NR	€ 1,05

Giunzione Pesante Mod.746



ad angolo stampata in acciaio tropicalizzato

 13460	40x40 mm	 50	UM NR	€ 0,59
 13461	80x80 mm	 25	UM NR	€ 1,05

Giunzione pesante Mod.747



ad angolo 135° in acciaio tropicalizzato

 13462	40x80 mm	 25	UM NR	€ 1,05
---	----------	--	-------	--------

Giunzione Mod.748



diritta in acciaio tropicalizzato

 13463	30x60 mm	 100	UM NR	€ 0,38
---	----------	---	-------	--------

Giunzione Mod.749



ad angolo pesanti stampate in acciaio tropicalizzato

mm	UM	€
13464 30x30	100 NR	0,46

Giunzione Mod.761



as U per travi inclinate in acciaio tropicalizzato

mm	UM	€
13467 70x80	10 NR	4,89
13468 90x90	10 NR	6,19

Giunzione Mod.751



pesante a T in acciaio tropicalizzato

mm	UM	€
13465 160x115	10 NR	3,95

Giunzione pesante Mod.770

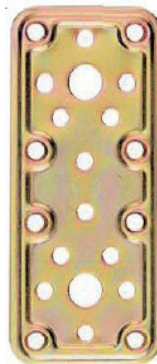

diritta stampata in acciaio tropicalizzato

mm	UM	€
09781 50X80	50 NR	0,75
09782 50X120	50 NR	1,00
09783 50X160	25 NR	1,28
13469 50x200	25 NR	1,48

Angolo Mod.752



pesante in acciaio tropicalizzato

mm	UM	€
13466 120x83x30	10 NR	1,76
09766 160x110x32	10 NR	1,92

Giunzione pesante Mod.771



ad angolo stampata in acciaio tropicalizzato

mm	UM	€
09776 40X40	50 NR	0,75
09777 60X60	50 NR	1,00
09778 80X80	25 NR	1,28
09779 100X100	25 NR	1,48

Giunzione Mod.754



a murare per pavimenti in acciaio tropicalizzato

mm	UM	€
09763 300x45x50	10 NR	4,12

Giunzione pesante Mod.772

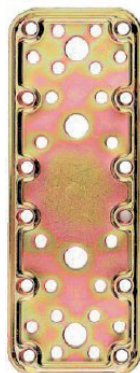

diritta stampata in acciaio tropicalizzato

mm	UM	€
09787 18	25 NR	1,62

Giunzione mod.760



pesante ad angolo 135° in acciaio tropicalizzato

mm	UM	€
09788 180	25 NR	1,87

Giunzione pesante Mod.773



ad angolo stampata in acciaio tropicalizzato

mm	UM	€
09784 90X90X65	25 NR	1,62

Giunzione pesante Mod.775



ad angolo stampata in acciaio tropicalizzato

mm	UM	€
09791 90X90X90	20 NR	2,22

Angolare mod.782



di rinforzo piegati a 90° sinistro in acciaio tropicalizzato

mm	UM	€
09786 17	20 NR	1,14

Giunzione mod.777



pesante pesanti ad angolo stampato in acciaio tropicalizzato

mm	UM	€
09790 66	25 NR	1,74

Giunzione mod.784



di estremità ad ali esterne in acciaio tropicalizzato

mm	UM	€
09768 80	10 NR	3,87
09769 90	10 NR	4,09
09770 100	10 NR	4,30

Giunzione pesante Mod.778



diritta stampata in acciaio tropicalizzato

mm	UM	€
09794 100	50 NR	0,27
09795 206	50 NR	0,48
09796 312	50 NR	0,70

Giunzione mod.785



di estremità ad ali esterne in acciaio tropicalizzato

mm	UM	€
09772 90	10 NR	4,09

Angolari Mod.779



di rinforzo piegati a 90° in acciaio tropicalizzato

mm	UM	€
13473 150x150	50 NR	0,78
13471 50x50	50 NR	0,33
13472 100x100	50 NR	0,56

Giunzione mod.786



di estremità a larghezza variabile in acciaio tropicalizzato

mm	UM	€
09774 100	10 NR	3,98
09775 140	10 NR	4,63

Angolare mod.781



di rinforzo piegati a 90° destro in acciaio tropicalizzato

mm	UM	€
09785 17	20 NR	1,14

Supporto mod.788



di ancoraggio registrabile in acciaio tropicalizzato

mm	UM	€
09761 60-140	4 NR	20,05

Supporto mod.800



per pilastri da avvitare in acciaio tropicalizzato

mm	UM	€
09797 70	4 NR	19,16
09798 90	4 NR	19,16

Supporto Mod.803



per pilastri ad avvitare registrabile in acciaio tropicalizzato

mm	UM	€
13474 171x53x32x47	8 NR	4,79

Cavallotti Mod.865

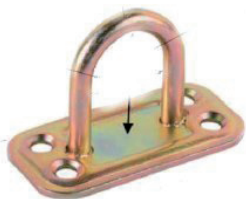

maglia tonda diam.mm.6-21x25 in acciaio tropicalizzato

mm	UM	€
13475 60x30	50 NR	2,98

Cavallotti Mod.866



pieghevoli maglia tonda diam.mm.6-21x48 in acciaio tropicalizzato

UM	€
10 NR	3,47

Maniglia Mod.950



filo diam.9 ingombro mm.50 con piastra stampata in acciaio tropicalizzato

mm	UM	€
13477 120	10 NR	5,16

Lastrina diritta



spessore mm.2 larghezza mm.15

cm	UM	€
09716 6	100 NR	0,07
09718 8	100 NR	0,08
09719 10	100 NR	0,10
09720 12	100 NR	0,12
09721 14	100 NR	0,13
09722 16	100 NR	0,15
09723 18	100 NR	0,17

Lastrina ad angolo



spessore mm.2 larghezza mm.15

cm	UM	€
09725 2X2	100 NR	0,06
09726 2,5X2,5	100 NR	0,07
09727 3X3	100 NR	0,07
09728 4X4	100 NR	0,08
09729 5X5	100 NR	0,10
09730 6X6	100 NR	0,12
09731 7X7	100 NR	0,13
09732 8x8	100 NR	0,15

Angolo di rinforzo

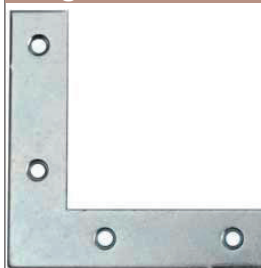

spessore mm.1,8 larghezza mm.12

cm	UM	€
09736 8	100 NR	0,23
09737 10	50 NR	0,28
09738 12	50 NR	0,32
09739 14	50 NR	0,36
09740 16	50 NR	0,42
09741 18	50 NR	0,48
09742 20	50 NR	0,57

Piastrina quadrata



zincata spessore mm.1

cm	UM	€
09744 4X4	200 NR	0,08

Piastrina piegata



spessore mm.1 larghezza mm.40

cm	UM	€
09745 2X2	100 NR	0,08

Piastrina ad angolo



pesante spessore mm.2,5 larghezza mm.40

mm	UM	€
09746 4,5X4,5	100 NR	0,30

Piastrina ad angolo



pesante spessore mm.2,5 larghezza mm.50 fori diam.mm.5

mm	UM	€
09747 60X60	50 NR	0,54
09748 80X80	25 NR	0,69
09749 100X100	25 NR	0,79

Squadretta verticale



bronzata ad asola verticale spessore mm.2

mm	UM	€
09715 22X28	100 NR	0,11

Cerniera Stretta Mod.120

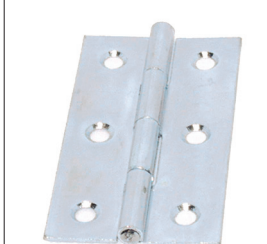

zincata per legno

mm	UM	€
04449 20	24 NR	0,39
04450 25	24 NR	0,53
04451 30	24 NR	0,56
04452 35	24 NR	0,58
04453 40	24 NR	0,61
04454 50	24 NR	0,68
92231 60	24 NR	0,80
04455 65	24 NR	0,83
04456 75	24 NR	0,92
92235 80	24 NR	0,97

Cerniera quadra Mod.121

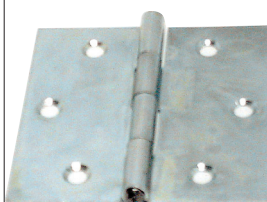

zincata per legno

mm	UM	€
04437 20	24 NR	0,53
04438 25	24 NR	0,53
04439 30	24 NR	0,58
04440 35	24 NR	0,61
04441 40	24 NR	0,62
04442 50	24 NR	0,72
92246 60	24 NR	0,87
04443 65	24 NR	0,92
04444 70	24 NR	1,04
04445 80	24 NR	1,30
04436 100	24 NR	1,74

Cerniera Lunga Mod.122

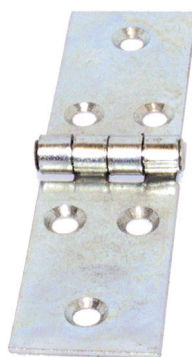

zincata per legno

mm	UM	€
04464 50	24 NR	0,64
04465 60	24 NR	0,70
04466 80	24 NR	0,83
04457 100	24 NR	0,97
04458 120	24 NR	1,16
04459 140	24 NR	1,32
04460 150	24 NR	1,44
04461 160	24 NR	1,63
04462 180	24 NR	1,88
04463 200	24 NR	2,53

Cerniera Extra Pesante Mod.127



per legno zincata

mm	UM	€
04616 50X50	10 NR	1,38
04617 64X65	10 NR	2,05
04618 75X65	10 NR	2,39
04619 75X75	10 NR	2,91
04620 90X75	10 NR	3,78
04615 100X100	10 NR	5,66

Cerniera a molla Mod.101



bommer doppia azione, pomoli cilindrici in acciaio bronzato

mm	UM	€
13402 75x34x28	1 CP	26,69
13403 100x37x33	1 CP	32,11

Chiudi Porta Mod.115

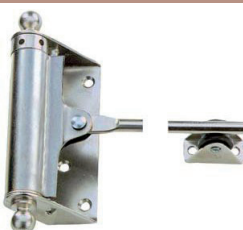

in acciaio zincato

mm	UM	€
13404 77x235	2 NR	10,84
13405 101x265	2 NR	13,20
13406 125x300	2 NR	15,60
13407 148x335	2 NR	19,16

Catenaccio Mod.215



trasversale leggero ricoperto in acciaio bronzato

mm	UM	€
13410 80x30	20 NR	3,63
13411 120x45	20 NR	3,99

Catenaccio Mod.216



trasversale leggero asta tonda in acciaio
bronzato

mm	UM	€
13412 80x30	10 NR	4,51
13413 120x45	10 NR	5,11

Catenaccio Mod.263A tropicalizzato



pesante AUTOMATICO a molla porta lucchetto
con fori - asta tonda diam.mm.12 in acciaio
tropicalizzato trivalente

- Scorrimento automatico dell'asta a molla
- Porta lucchetto di sicurezza
- Utilizzo trasversale o verticale - con incontro o senza incontro
- 3 posizioni in chiusura - pomolo ribaltato a destra o sinistra con lucchetto - pomolo al centro senza lucchetto
- Grazie alla molla è sempre garantita la chiusura anche senza raggiungere la posizione di fine corsa
- Le apposite cave, alloggiamenti del pomolo e l'azionamento a molla, garantiscono le posizioni di chiusura a apertura, anche con sollecitazioni

mis	UM	€
13424 20	6 NR	15,45
13425 30	6 NR	16,79

Catenaccio Mod.248



porta lucchetto leggero asta tonda in acciaio
bronzato

mm	UM	€
13415 105x30	10 NR	5,71

Catenaccio Mod.263A zincato



pesante AUTOMATICO a molla porta lucchetto
con fori - asta tonda diam.mm.12 in acciaio
zincato

- Scorrimento automatico dell'asta a molla
- Porta lucchetto di sicurezza
- Utilizzo trasversale o verticale - con incontro o senza incontro
- 3 posizioni in chiusura - pomolo ribaltato a destra o sinistra con lucchetto - pomolo al centro senza lucchetto
- Grazie alla molla è sempre garantita la chiusura anche senza raggiungere la posizione di fine corsa
- Le apposite cave, alloggiamenti del pomolo e l'azionamento a molla, garantiscono le posizioni di chiusura a apertura, anche con sollecitazioni

mis	UM	€
13422 20	6 NR	15,45
13423 30	6 NR	16,79

Catenaccio Mod.250



porta lucchetto asta tonda in acciaio bronzato

mis	UM	€
13416 15	10 NR	10,63
13417 20	10 NR	13,23
13418 25	10 NR	15,59

Catenaccio Mod.267



trasversale pesante porta lucchetto con fori
asta tonda diam.mm.16 in acciaio tropicalizzato
trivalente

mis	UM	€
13426 20	4 NR	16,11
13427 30	4 NR	24,23

Catenaccio Mod.263



trasversale pesante, porta lucchetto con fori
asta tonda mm.12 in acciaio zincato

mis	UM	€
13419 10	6 NR	11,84
13420 15	6 NR	12,55
13421 20	6 NR	13,67

Ruota sciolta



In Gomma - Boccola in nylon - Nucleo in acciaio

mm	port.kg	UM	€
93478 80	60	12 NR	1,80
93479 100	80	10 NR	2,11
93489 125	100	12 NR	3,88
93490 160	150	1 NR	8,14
93491 200	180	1 NR	11,62

Ruota Piastra fissa



In Gomma - Boccola in poliammide - Nucleo e
piastra in acciaio

mm	port.kg	UM	€
93492 80	60	10 NR	4,68
93493 100	80	1 NR	5,15
93494 125	100	6 NR	7,34
93495 160	150	1 NR	15,37
93496 200	180	1 NR	19,33

Ruota Piastra girevole



In Gomma - Boccola in poliammide - Nucleo e piastra in acciaio

mm	port.kg	UM	€
93497 80 60 10 NR	5,96		
93498 100 80 5 NR	6,38		
93499 125 100 5 NR	8,49		
93500 160 150 1 NR	19,64		
93501 200 180 1 NR	21,18		

tellure Rôta

Ruota Piastra Fissa



in Poliuretano TR con nucleo in alluminio

mm	port.kg	UM	€
04135 80X20 200 6 NR	19,54		
04136 100X25 200 6 NR	27,15		
04137 125X30 220 6 NR	30,11		
04134 150X40 220 4 NR	43,19		

Ruota Piastra Girevole con Freno



In Gomma - Boccola in poliammide - Nucleo e piastra in acciaio

mm	port.kg	UM	€
93502 80 60 5 NR	8,84		
93503 100 80 8 NR	8,42		
93504 125 100 5 NR	10,39		
93505 160 150 1 NR	21,15		
93506 200 180 1 NR	24,58		

Ruota Piastra Girevole



in Poliuretano TR con nucleo in alluminio

mm	port.kg	UM	€
04138 80X20 200 12 NR	22,09		
04139 100X25 200 12 NR	29,69		
04140 125X30 220 12 NR	34,08		
04141 150X40 B 220 4 NR	47,81		

tellure Rôta

Ruota sciolta



in gomma, boccola in nylon, nucleo in acciaio

mm.	port.Kg.	UM	€
04126 125X37,5 130 6 NR	4,02		
04129 150X40 170 6 NR	6,02		
04128 180X45 200 4 NR	10,24		

tellure Rôta

Ruota mobilio piastra Girevole



in poliammide nero in blister Pz.2

mm	UM	€
51793 40X20 12 BL	7,99	
51794 50X20 12 BL	8,20	
51795 60X22 12 BL	11,62	

tellure Rôta

Ruota Piastra Fissa



in gomma, boccola in poliammide, nucleo e piastra in acciaio

mm	port.kg	UM	€
51583 80X25 65 6 NR	6,31		
51584 100X30 80 6 NR	6,82		
51585 125X37,5 130 6 NR	9,11		
51586 150X40 170 6 NR	11,11		
51587 180X45 200 4 NR	21,37		
10221 200x50 230 2 NR	21,45		

tellure Rôta

Ruota mobilio con Vite



in poliammide nero in blister Pz.2

mm	UM	€
51796 40X20 12 BL	8,14	
51797 50X20 12 BL	8,36	
51798 60X24 12 BL	11,77	

tellure Rôta

Ruota Piastra Girevole



in gomma, boccola in poliammide, nucleo e piastra in acciaio

mm	port.kg	UM	€
51588 80X25 65 12 NR	8,78		
51589 100X30 80 12 NR	9,29		
51590 125X37,5 130 12 NR	13,18		
51591 150X40 170 12 NR	15,19		
51592 180X45 200 4 NR	27,40		
53491 200X50 230 2 NR	27,48		

tellure Rôta

Ruota mobilio Semisferica



in gomma nera in blister Pz.2

mm	UM	€
51803 45 DX 12 BL	10,11	
51804 55 DX 12 BL	11,64	

tellure Rôta

Ruota Piastra Girevole con Freno



in gomma, boccola in poliammide, nucleo e piastra in acciaio

mm	port.kg	UM	€
04130 80X25 65 12 NR	15,68		
04131 100X30 80 12 NR	16,19		
04132 125X37,5 130 12 NR	20,08		
04133 200X50 230 2 NR	37,99		

tellure Rôta

Ruota mobilio Gemellata



in poliammide nero in blister Pz.2

mm	UM	€
51805 50X59 12 BL	5,83	

tellure Rôta

Ruota mobilio piastra Girevole



con parafile in gomma grigia in blister pz.2

mm	UM	€
51799 50X20	8 BL	13,12
51800 60X24	8 BL	20,13

Ruota mobilio con Vite



con parafile in gomma grigia in blister Pz.2

mm	UM	€
51801 50X20	8 BL	13,37
51802 60X24	8 BL	20,38

Ruota pneumatica



Ruota pneumatica con camera d'aria - Fulcro in PVC - Asse con rotazione su cuscinetto mm.260x85 F20

	UM	€
91420	1 NR	11,77
61177 tappo ferma ruote	1 NR	0,40

Ruota pneumatica



Ruota pneumatica con camera d'aria - Fulcro in metallo - Asse con rotazione su cuscinetto mm.260x85 F20

	UM	€
91770	1 NR	13,11

Ruota piena



Fulcro in metallo - Asse di rotazione su cuscinetto - mm.260x85 F20

	UM	€
93552	1 NR	19,08



in alluminio richiudibile portata kg.60 pedana cm.39x28 Larghezza con ruote cm.39x41 Altezza cm.101

	UM	€
91766	1 NR	66,30



in alluminio richiudibile portata kg.90 pedana cm.34x27 Larghezza con ruote cm.49x46 Altezza cm.96,5

	UM	€
91767	1 NR	95,75



portatutto multiuso con freno telaio in alluminio portata kg.200 pianale LxH cm.110x105 Altezza cm.132

	UM	€
91768	1 NR	268,69
61347 ruota	1 NR	21,29



in alluminio/acciaio richiudibile portata kg.90 pedana cm.35x24 Larghezza con ruote cm.39x39 Altezza cm.110

	UM	€
86839	1 NR	54,54
60533 ruota	1 NR	4,91



in alluminio/acciaio estensibile e pieghevole portata kg.150 pedana cm.41x63 Larghezza con ruote cm.41x41 Altezza cm.71/83

	UM	€
86840	1 NR	82,16
60535 ruota fissa	1 NR	4,37
60534 ruota girevole	1 NR	5,42



per casse, sacchi, fusti portata kg.200 pedana cm.45x26 Larghezza con ruote cm.50x51 Altezza cm.117 con ruote pneumatiche

	UM	€
87128	1 NR	84,38
16544 manopola	1 NR	0,91



per casse, sacchi, fusti portata kg.200 pedana cm.45x22 Larghezza con ruote cm.50x51 Altezza cm.112 con ruote pneumatiche

Articolo	UM	€
84539	1 NR	67,80
16544 manopola	1 NR	0,91



pala ribaltabile per scatole, portata kg.200 pedana cm.53x31 Larghezza con ruote cm.54x49 Altezza cm.108 con ruote pneumatiche

Articolo	UM	€
88760	1 NR	119,30
16544 manopola	1 NR	0,91



pala ribaltabile per gradini, portata kg.200 pedana cm.53x31 Larghezza con ruote cm.55x57 Altezza cm.128

Articolo	UM	€
81291	1 NR	125,20
61197 ruota	1 NR	32,49

Maniglia



Articolo	mm	UM	€
61176	32	1 NR	1,24
61175	25	1 NR	1,06

Transpallet



portata kg.2500 lunghezza forche mm.1100 larghezza mm.550 altezza max.80:200 Peso kg,80

Articolo	UM	€
86282	1 NR	506,09
60298 Ruota anteriore	1 NR	74,12
60299 Ruota girev.post.	1 NR	45,33
61057 Guarnizione	1 NR	30,89

Cavalletto pieghevole



in legno cm.80x75

Articolo	UM	€
81376 Faggio	35 NR	9,43
10785 Abete	35 NR	8,15

Cassetta Portautensili Mod.PRO 22

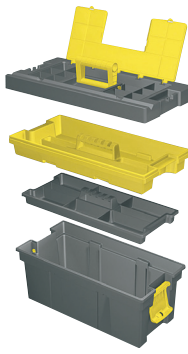

22" professionale con coperchio rimovibile a doppia chiusura. Dispone di maniglia a scomparsa, organizer sul top e, al suo interno, di 2 vassoi rimovibili. Misure cm (L x P x H):L 57,5 cm. x P 27,5 cm. x H 29 cm.

Articolo	UM	€
07342	3 NR	47,07

Cassetta Portautensili Mod.PRO 18



18" professionale con coperchio rimovibile a doppia chiusura. Dispone di maniglia a scomparsa, organizer sul top e, al suo interno, di un vassoio rimovibile. Misure cm (L x P x H):L 44,5 cm. x P 26,5 cm. x H 25 cm.

Articolo	UM	€
07343	3 NR	29,95

Cassetta portautensili

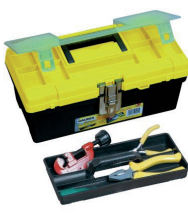

in polipropilene, coperchio con vaschetta portaminuterie

Articolo	mm	UM	€
91955	330x175x145	6 NR	5,91
91956	405x225x205	6 NR	11,00
91957	485x275x250	6 NR	16,95

Cassetta portautensili Tris



in polipropilene Cod.91955-91956-91957

Articolo	UM	€
91958	1 NR	36,92

Cassetta portautensili lamiera



in lamiera verniciata

Articolo	mm	cm	UM	€
86604	5 scomp.	45	6 NR	32,08
88694	5 scomp.	53	2 NR	36,41

Cassetta portautensili



metallo /plastica a 5 scomparti con 2 maniglie pieghevoli

Articolo	mm	UM	€
92203	45x21x23	1 NR	31,46
92204	59x21x23	1 NR	39,04

Cassetta portautensili



polipropilene con vassoio

Articolo	cm.	UM	€
92206	50x30x22	1 NR	24,83

Cassetta portaminuterie



in polipropilene 4 cassette coperchio con 2 vaschette

Articolo	mis.	UM	€
92208	43x23x30	1 NR	25,58

Valigetta Portautensili



in polipropilene, coperchio con vaschette portaminuterie

Articolo	mm	UM	€
91959	360x323x145	8 NR	10,51

Portaminuterie Organizer



con separatori interni rimovibili

Articolo	mm	UM	€
87708	443x317x80	8 NR	14,46

Portaminuterie Organizer



In polipropilene - Con pratici separatori interni rimovibili - Confezione in film termoretraibile

Articolo	mm	scom	UM	€
93077	320x260x50	21	NR 48	3,05
93078	28,5x23,5x65	21	NR 16	5,28
93079	480x380x80	24	NR 8	14,18

Portaminuterie Organizer



In polipropilene - Con pratici separatori interni rimovibili - Doppia apertura - Confezione in film termoretraibile - 30 Scomparti

Articolo	mm	UM	€
93080	330x220x70	1 NR	

Portaminuterie Organizer



In polipropilene - Con pratici separatori interni rimovibili - Valigetta con doppia apertura

Articolo	mm	UM	€
95117	380x330x120H	1 NR	17,66

Cassetta Organizer



in polipropilene

Articolo	mm	scom	UM	€
91964	210x125x35	18	NR 24	2,44
91965	270x186x42	18	NR 12	4,53

Cassetta portaminuterie



In polipropilene cassette trasparenti mis.382x148x230

Articolo	cassette	UM	€
51706	8	NR 8	22,10
51705	12	NR 8	22,31

Cassetta portaminuterie

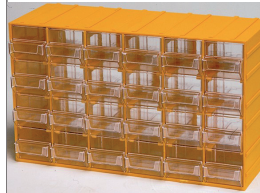

In polipropilene cassette trasparenti mis.382x148x230

Articolo	cassette	UM	€
06067	16	NR 8	25,44
51704	24	NR 8	29,73

Baule con ruote



in polipropilene, coperchio con vaschette portaminuterie

Articolo	mm	UM	€
91960	610x375x415	NR 2	68,20
91961	750x487x493	NR 1	46,63

Trolley con ruote



acciaio/polipropilene 3 in 1 divisibile

Articolo	mm	UM	€
91963	580x345x670	NR 1	73,58

Carrello Portautensili





Pratico carrello portautensili in polipropilene copolimero ad alta resistenza - Ideale per lavori di officina ed in garage - Ampio ripiano da lavoro con tappetino portaoggetti incluso - 4 livelli di appoggio e 2 ampi cassetti con chiusura - Manico in doppia gomma termoplastica con incavo per arrotolare cavi elettrici e lampade - Ruote piroettanti con portata fino a 100 kg.

 cm
95118 78x41,5x89H  UM €
1 NR 85,85

Contenitore Mod.UNIONBOX



modulare componibile ad incastro sui tre lati, dotato di porta etichetta.



 mod	mm	 UM	€
03908 A	104X165X76	60 NR	2,14
03909 B	147X234X129	30 NR	5,21
03910 C	218X234X129	16 NR	6,69
03911 D	210X341X167	10 NR	9,49
03912 E	307X500X190	4 NR	18,05
03913 F	380X610X250	4 NR	37,97



Contenitore Industriale





modulare componibile ad incastro su 2 lati dotato di portaetichetta

 mod	mm	 UM	€
54441 A2	104x165x76	60 NR	1,29
54442 B3	147x234x129	24 NR	3,17
54443 D4	210x341x167	21 NR	6,31
54444 E5	307x500x190	12 NR	12,31

Armadio MINI SPAZIO



in metallo a 1 porta con 1 piano estraibile e regolabile con serratura.

 cm
52028 50x40x80  UM €
1 NR 97,99

Armadio MINI SPAZIO



in metallo a 2 porte con 1 piano estraibile e regolabile, con serratura.

 cm
52029 80x40x80  UM €
1 NR 115,49

Armadio PORTASCOPE



in metallo a 1 porta a 4 piani con serratura. Misura cm.60x40x176

 cm
52024 60x40x176  UM €
1 NR 160,98

Armadio PORTASCOPE



in metallo a 2 porta a 4 piani con serratura.

 cm
52025 80x40x176  UM €
1 NR 192,48

Armadio TUTTOPIANI



in metallo a 1 porta a 4 piani con serratura.

 cm
52026 60x40x176  UM €
1 NR 160,98

Armadio TUTTOPIANI



in metallo a 2 porte a 4 piani con serratura.

 cm
52027 80x40x176  UM €
1 NR 192,48

Armadio SPORCO/PULITO



Struttura portante in lamiera d'acciaio profilata. Costruito con porte rinforzate munite di asole per areazione. Dotazione interna: pianetto e portaombrelli. Chiusura con serratura a cilindro.

Articolo	cm	UM	€
02687	50x40x180	1 NR	167,98

Armadio TUTTOPIANI



in polipropilene a 2 ante 4 ripiani

Articolo	cm	UM	€
54950	68x37x169	1 NR	85,29

Armadio SPOGLIATOIO



Struttura portante in lamiera d'acciaio profilata. Costruito in versioni da 1-2-3 porte con antine munite di asole per areazione. Dotazione interna: pianetto e portaombrelli. Chiusura con serratura a cilindro.

Articolo	posti	cm	UM	€
02688	1	36x33x180	1 NR	115,49
02705	2	69x33x180	1 NR	174,98
02710	3	101x33x180	1 NR	223,97

Scaffale 5 ripiani



in polipropilene misura LxPxH cm.70x35x172

Articolo	UM	€
90899	1 NR	53,14

Ripiani per armadi



Articolo	cm	UM	€
05136	50	1 NR	7,87
05137	60	1 NR	8,75
10838	70	1 NR	9,10
05138	80	1 NR	9,45

Armadio MINI SPAZIO



in polipropilene a 2 ante

Articolo	cm	UM	€
90934	70x39x92	1 NR	51,47

Armadio PORTASCOPE



in polipropilene a 2 ante con ripiani e vano portascopio

Articolo	cm	UM	€
54951	68x37x169	1 NR	85,29

Scaffale in Kit



a 5 ripiani zincato ad incastro

Articolo	cm	UM	€
81110	100x40x184	1 NR	46,95

Ripiano scaffali



in ferro grigio RAL 7038

Articolo	mm	UM	€
51201	600X300	5 NR	5,70
51202	600X400	5 NR	7,46
51976	700X300	5 NR	6,65
52668	700X400	5 NR	8,69
51174	800X300	5 NR	6,91
51635	800X400	5 NR	9,03
51175	800X400R	5 NR	10,31
51176	800X500R	5 NR	11,95
51203	1000X300	5 NR	8,38
51177	1000X400R	5 NR	11,35
51178	1000X500R	5 NR	13,65
51179	1000X600 2R	5 NR	18,51
51392	1200X300	5 NR	9,98
51180	1200X400R	5 NR	14,16
51181	1200X500R	5 NR	16,52
51182	1200X600 2R	5 NR	21,11
51636	1500X500R	5 NR	25,19

Angolari per scaffali

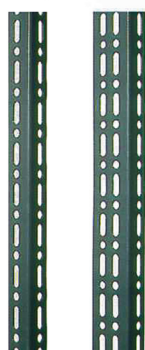

mm	mt	UM	€
51183 38X38	2	1 NR	5,82
51184 38X38	2,5	1 NR	7,26
51185 38X38	3	1 NR	8,70
52593 38X58	1	1 NR	3,69
51204 38X58	2	1 NR	7,39
51205 38X58	2,5	1 NR	9,20
51251 38X58	3	1 NR	11,08

Piedino per angolari



mm	UM	€
04521 35x35	1 NR	0,29
04522 35x55	1 NR	0,39

Bullone per scaffale



UM	€
04292 bullone	40 NR 0,10

Pannello lamiera

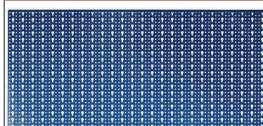

forato colore blu

CM	UM	€
52023 con ganci 100X40	1 NR	30,42
83588 100X50	10 NR	20,24

Gancio nylon Mod.B01

per pannello forato



UM	€
05514	200 NR 0,25

Gancio nylon Mod.B02

per pannello forato



mod.	UM	€
05515 B02	100 NR	0,25

Gancio nylon Mod.B03

per pannello forato



mod.	UM	€
05516 B03	100 NR	0,25

Gancio nylon Mod.B04

per pannello forato



mod.	UM	€
05517 B04	100 NR	0,25

Gancio per Espositore Mod.272

in ferro zincato cromato



cm	UM	€
06885 20	100 NR	0,57
06886 30	50 NR	0,80

Gancio per Espositore Mod.273

in ferro zincato cromato



cm	UM	€
07064 5	50 NR	0,33
07063 15	50 NR	0,48
06887 20	50 NR	0,58
06888 30	50 NR	0,77

Gancio per Espositore Mod.265

in ferro zincato cromato



cm	UM	€
06884 30	50 NR	1,50

Gancio Multiuso

fischer



mod.	col.	UM	€
06238 MKH W	bianco	30 NR	3,71
06237 MKH TP	trasparente	30 NR	3,71

Reggimensola zincata bianca



cm	UM	€
02870 30	10 NR	2,56
02871 40	10 NR	2,81
06483 50	10 NR	3,68

Mensola nervata Grigia



in acciaio verniciato

mm	UM	€
80310 100X75	24 NR	0,29
80311 125X100	24 NR	0,41
80312 150X125	24 NR	0,51
80313 200X150	24 NR	0,76
80314 250X200	24 NR	1,08
80315 300X250	24 NR	1,64
80316 350X300	12 NR	2,31

Mensola nervata Bianca



in acciaio verniciato

mm	UM	€
83171 100X75	24 NR	0,36
83172 125X100	24 NR	0,41
83173 150X125	24 NR	0,51
83174 200X150	24 NR	0,77
83175 250X200	24 NR	1,08
83176 300X250	24 NR	1,64
83177 350X300	12 NR	2,31

Mensola a COLONNA



per calorifero in coppia (destra/sinistra)

UM	€
02861 1 CP	6,11

Mensola a PIASTRA



per calorifero in coppia (destra/sinistra)

UM	€
02869 1 CP	6,59

Mensola pesante



spessore mm.5 larghezza mm.30

cm	UM	€
09750 30	10 NR	4,55
09751 40	10 NR	5,70
09752 50	10 NR	7,14

Mensola Mod.2522



in acciaio stampato verniciatura a polveri epossidiche senza viti e tasselli

cm	kg	UM	€
13428 15	25	10 NR	1,11
13429 20	40	10 NR	1,63
13430 25	35	10 NR	1,99
13431 30	39	10 NR	2,92
13432 25	33	10 NR	3,31

Mensole Mod.3522



in acciaio stampato con saetta di rinforzo senza viti e tasselli

cm	kg	UM	€
13433 30	150	10 NR	3,91
13434 40	180	10 NR	6,51
13435 50	170	10 NR	8,62

Mensola Mod.2534



ribaltabile a 3 posizioni in acciaio zincato senza viti e tasselli

cm	kg.	UM	€
13436 30	200	4 NR	13,60
13437 40	200	4 NR	16,87

Mensola Mod.2576



in acciaio verniciato extra forti, portata fino a 300 Kg.

cm	col.	UM	€
16707 30	bianca	10 NR	5,62
16708 40	bianca	10 NR	7,42
16709 50	bianca	10 NR	9,18
16710 30	nera	10 NR	5,62
16711 40	nera	10 NR	7,42
16712 50	nera	10 NR	9,18

Mensola Mod.2576 Super



di grande portata in acciaio stampato zincato senza viti e tasselli - AGGANCIAMENTO DI SICUREZZA BREVETTATO - Montaggio facilitato

cm	kg	UM	€
16223 30	400	10 NR	6,25
16224 40	350	10 NR	8,47
16225 50	350	10 NR	10,80

Mensola per cremagliera



in acciaio stampato zincato, verniciatura a polveri epossidiche

cm	Kg	UM	€
14675 20	100	10 NR	1,71
14676 25	90	10 NR	2,05
14677 30	75	10 NR	2,55
14678 35	60	10 NR	3,11
14679 40	40	10 NR	3,65
14680 40	90	10 NR	5,32

Profilo cremagliera



in acciaio stampato zincato, verniciatura a polveri epossidiche

cm	UM	€
14681 100	1 NR	7,04
14682 198	1 NR	12,83

Tappo per profilo



in conf.pz.2

cm	UM	€
14683	1 CF	1,30

Distanziale per profilo



in plastica nera

mm	UM	€
14684 122	1 CF	3,03
14685 198	1 CF	4,20

Espomensole



Espositore mensole assortite Pz.166

cm.	UM	€
13495 50X56X180	1 NR	843,62

Ripiani Storage



in legno bordati in PVC - alto spessore in OSB spessore mm.20 +/- mm.2

- Alta resistenza meccanica
- Forte rigidità
- Nessuna deformazione
- Ottima tenuta delle viti
- Superficie decorativa liscia e dall'aspetto unico

cm	UM	€
13478 30X50	4 NR	13,76
13479 30X100	4 NR	17,23
13481 50X100	4 NR	27,79
13480 40X100	4 NR	22,19

Esporipiani



Espositore di ripiani assortiti Pz.51

cm.	UM	€
13494 50X56X180	1 NR	929,22

Appendimanici da parete

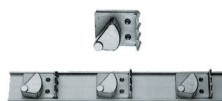

con pinza a camma in plastica per manici cilindrici

mod	UM	€
86732 1 posto	1 NR	4,49
86733 3 posti	1 NR	15,91

Slitte per mobili



lunghezza regolabile 400-600 mm., pedalina con freno ruota in Cf.Pz.2

mm	UM	€
87597	24 NR	10,03

Feltrini tondi



adesivi in blister

colore	mm	UM	€
81576 BIANCHI	18	100 BL	0,27
81551 BIANCHI	20	100 BL	0,27
81577 BIANCHI	22	100 BL	0,27
81552 BIANCHI	24	100 BL	0,27
81578 BIANCHI	26	100 BL	0,27
81579 BIANCHI	28	100 BL	0,27
81580 BIANCHI	32	100 BL	0,27
81581 NOCE	18	100 BL	0,27
81553 NOCE	20	100 BL	0,27
81582 NOCE	22	100 BL	0,27
81554 NOCE	24	100 BL	0,27
81583 NOCE	26	100 BL	0,27
81584 NOCE	28	100 BL	0,27
81585 NOCE	32	100 BL	0,27

Feltrini quadrati



adesivi in blister

colore	mm	UM	€
81555 BIANCHI	20	100 BL	0,27
81556 BIANCHI	25	100 BL	0,27
81586 BIANCHI	30	100 BL	0,27
81557 NOCE	20	100 BL	0,27
81558 NOCE	25	100 BL	0,27
81588 NOCE	30	100 BL	0,27

Feltrini rettangolari



adesivi

colore	mm	UM	€
81590 BIANCHI	25X50	100 BL	0,27
81591 BIANCHI	25X80	100 BL	0,27
81592 BIANCHI	50X100	100 BL	0,27
81593 NOCE	25X50	100 BL	0,27
81594 NOCE	25X80	100 BL	0,27
81595 NOCE	50X100	100 BL	0,27

Arella

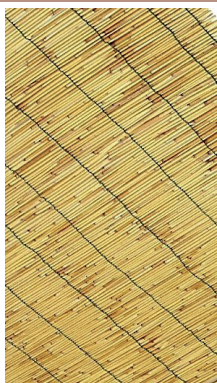

canniccio termosingolo con legatura in nylon

mt	UM	€
16466 1x3	10 NR	6,71
16467 1x5	5 NR	11,18
16468 1,5x3	5 NR	10,08
16469 1,5x5	5 NR	16,79
16470 2x3	5 NR	13,42
16471 2X5	3 NR	22,37
16472 2,5x4	2 NR	22,37

Zanzariera in Kit



rete fibra di vetro, avvolgimento a frizione, facilità di installazione, guide telaio e coprirullo in alluminio anodizzato bronzo

H	cm	UM	€
86090 160	80/60	1 NR	43,68
86091 160	100/80	1 NR	47,87
86092 160	120/100	1 NR	50,67
86093 160	140/120	1 NR	55,91
86094 160	160/140	1 NR	66,40
86095 250	80/60	1 NR	52,50
86096 250	100/80	1 NR	68,25
86097 250	120/100	1 NR	72,96
86098 250	140/120	1 NR	77,72
86099 250	160/140	1 NR	82,47

Zanzariera in Kit Laterale



rete fibra di vetro, avvolgimento a frizione, facilità di installazione, guide telaio e coprirullo in alluminio anodizzato bronzo chiusura laterale

cm	UM	€
86088 140X250	1 NR	83,44
86089 160X250	1 NR	97,22

Zanzariera magnetica



in poliesteri a due teli, per qualsiasi tipo di porta/finestra applicabile su velcro adesivo in dotazione, due strisce magnetiche centrali per apertura e chiusura del telo zanzariera autotensionante. Colore nero.

cm	UM	€
95503 120x240	1 PZ	9,69

Zanzariera con Velcro

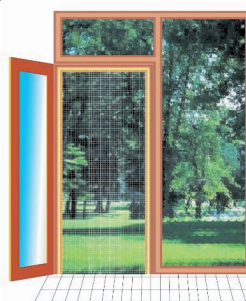

per porte cm.75x250

colore	UM	€
88729 bianca	20 NR	6,71
88730 antracite	20 NR	6,71

Zanzariera con velcro

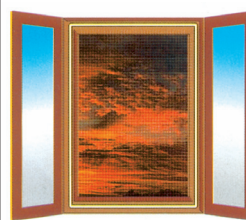

per finestre

mt	colore	UM	€
88731 1,3X1,5	BIANCO	20 NR	4,47
88727 1,5X1,8	BIANCO	20 NR	5,03
88732 1,3X1,5	ANTRACITE	20 NR	4,47
88728 1,5X1,8	ANTRACITE	20 NR	5,03

Zanzariera a pannelli



verticali

cm	pann	UM	€
92574 80x240	3	6 NR	16,52
92575 100x240	4	6 NR	19,83
92576 120x240	5	6 NR	22,02

Rete Zanzariera



in alluminio maglia 18x14 in rotolo da mt.30

H	UM	€
80321 60	1 RT	75,84

Articolo	H	UM	€
85921	70	1 RT	86,21
80322	81	1 RT	101,15
80409	100	1 NR	126,41
80324	120	1 RT	151,72

Rete Zanzariera



in fibra vetro maglia 18x16 in rotolo da mt.30

Articolo	H	UM	€
80327	81	1 RT	46,53
84450	100	1 RT	58,16
80329	120	1 RT	69,79
80330	150	1 RT	87,24

Nastro velcro

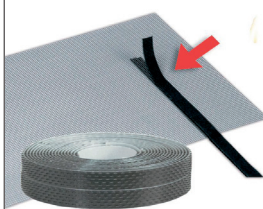

per rete zanzariera poliestere cm.1 mt.6,5

Articolo	UM	€
88733	50 NR	3,21

Puliscizanzariera



spazzola e spugna

Articolo	UM	€
90758	1 NR	7,08

Targhetta segnanome



con givolare

Articolo	UM	€
01721	100 NR	0,16

Bilancina a strappo



Articolo	kg	UM	€
02658	12,5	12 NR	4,35
02661	25	6 NR	5,75
02664	50	6 NR	9,33
02657	100	6 NR	15,98

Parafreddo Spugna



in resina espansa autoadesivo

Articolo	mm	mt	UM	€
02556	10	8	50 NR	0,80
02555	15	8	34 NR	0,99
02557	20	8	25 NR	1,22
02558	30	4	34 NR	1,01

Parafreddo PVC

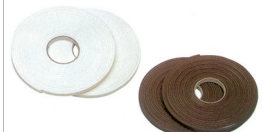

autoadesivo sez.9x3 mm profilo E

Articolo	colore	UM	€
02559	bianco	50 NR	1,96
02560	marrone	50 NR	1,96

Parafreddo Gomma



autoadesivo Colore Nero - Evita le infiltrazioni, isolante acustico, antigelo, anticondensa
- Utilizzato nei settori condizionamento, refrigerazione, serramenti e carrozzeria

Articolo	mt	mm	UM	€
88198	10	10x5	60 NR	3,08
88199	10	15x5	40 NR	4,24
88200	10	20x5	30 NR	5,29
14119	10	25x5	24 NR	6,38
88201	10	30x5	20 NR	7,42
14120	5	15x10	40 NR	4,24
14121	5	20x10	30 NR	5,29
14122	5	25x10	24 NR	6,38

Parafreddo Gomma



autoadesivo Profilo E mt. 6

Articolo	colore	UM	€
54077	bianco	50 NR	1,99
52434	marrone	50 NR	1,99

Parafreddo Gomma



autoadesivo Profilo P mt. 6

Articolo	colore	UM	€
88202	bianco	50 NR	2,09
88203	marrone	50 NR	2,09

Parafreddo per Porte



in PVC morbido con feltro cm.100

Articolo	cm	colore	UM	€
02552	100	bianco	50 NR	0,71
02553	100	marrone	50 NR	0,71

Parafreddo per Porte



in PVC rigido con spazzolino cm.100

Articolo	cm	colore	UM	€
52490	100	marrone	25 NR	2,57
52489	100	bianco	25 NR	2,57

Copricalorifero



universale in fibra poliestere Il copricalorifero ha due lati cuciti al fine di evitare la caduta dal radiatore. Lavabile e riutilizzabile

Articolo	mt	UM	€
54078	2	12 NR	4,24

Filtro calorifero



in rotolo - per filtrare la polvere presente nell'aria calda emessa dai caloriferi - colore bianco

	cm	mt		UM	€
14125	33	25	1	RT	21,27

Parafreddo calorifero



in alluminio materiale termorifrangente, per evitare la dispersione di calore attraverso i muri. Da applicare dietro i caloriferi

		UM	€
14126	1	RT	95,91

Corda Poliestere



treccia di poliestere 100% media tenacità - Calza esterna: poliestere Anima: poliestere

	mm	± mt.		UM	€
02632	4	450	8	KG	5,67
02633	5	350	9	KG	5,67
02634	6	300	9	KG	5,67
02635	8	400	20	KG	5,67
02626	10	250	20	KG	5,67
02627	12	200	22	KG	5,67
02628	14	170	27	KG	5,67
02629	16	145	28	KG	5,67
02630	18	145	35	KG	5,67
02631	20	115	35	KG	5,67

Spago imballo

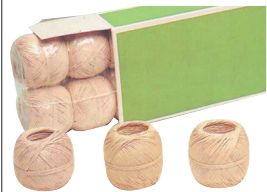

	mis	gr	cf		UM	€
02642	2-2/2	100	10	1	CF	12,97
02643	2-2/4	100	10	1	CF	14,78
02644	2-2/6	100	10	1	CF	20,28
02646	2-3/4	500	6	1	CF	31,31

Spago candido



mis.2/6 in conf.pz.10 da gr.100

		UM	€
02645	1	CF	18,94

Treccia veneziana



mm.3 conf.Mt.500

	colore		UM	€
09580	bianca	1	RT	34,91
09581	verde	1	RT	34,91

Treccia riloga



bianca mm.2,5 mt.500

		UM	€
09582	1	RT	25,43

Cintino Tapparelle



bicolore in cotone rinforzato

	mt		UM	€
87449	5,5	1	NR	2,29
87450	7,5	1	NR	2,95

Cintino Tapparelle



bicolore in cotone gr.170 in rotolo mt.50

		UM	€
02637	50	MT	0,44

Fune Elastica



elastica con 2 ganci di sicurezza mm.25 estensione ml.4

		UM	€
83062	20	NR	8,78

Corda Elastica



con ganci in conf.Pz.2

	mm/cm		UM	€
85983	8X80	12	CP	2,57
85984	8X100	12	CP	2,98
85985	8X120	12	CP	3,30
85987	8X150	12	CP	3,85
85988	8X200	12	CP	4,75

Corda Elastica in bobina



in polipropilene mm.8 conf.mt.200

		UM	€
92978	1	NR	188,50

Gancio acciaio per fune elastica



In acciaio verniciato nero - Confezione in blister da 2 pz. - per fune mm.8

		UM	€
92979	2	CP	0,69

Cinghia Ancoraggio

100 Kg.



nastro poliestere senza ganci morsetto a pressione Larghezza mm.1,2x25 Lunghezza Mt.4,5 - Portata Massima 100 Kg.

84206	UM	€
20	CP	7,01

Cinghia Ancoraggio

125 Kg.



nastro poliestere con 2 ganci a S morsetto a pressione Larghezza mm.1x25 Lunghezza mt.1,9 - Portata Massima 125 Kg.

80365	UM	€
20	CP	11,29

Cinghia Ancoraggio

250 Kg.



nastro poliestere con 2 ganci a S morsetto a cricchetto Larghezza mm.1x25 Lunghezza mt.4,5 - Portata Massima 250 Kg.

84207	UM	€
10	CP	12,73

Cinghia Ancoraggio

400 Kg.



nastro poliestere con 2 ganci morsetto a cricchetto Larghezza mm.1x30 Lunghezza mt.5 - Portata Massima 400 Kg.

92976	UM	€
6	CP	27,01

Cinghia Ancoraggio

500 Kg.



nastro poliestere con 2 ganci morsetto a cricchetto Larghezza mm.1,2x50 Lunghezza mt.6 - Portata Massima 500 Kg.

86184	mt.	UM	€	
6		6	NR	17,94

Cinghia Ancoraggio

1000 Kg.



nastro poliestere con 2 ganci morsetto a cricchetto Larghezza mm.2x50 Lunghezza mt.9 - Portata Massima 1000 Kg.

80367	UM	€
4	NR	34,22

Cinghia Ancoraggio



in polipropilene stabilizzato con fibbia in alluminio. Carico di rottura ad anello chiuso 250 Kg.

cod.	mm.	mt.	col.	UM	€
16702	25	1,5	verde	6 NR	1,97
16703	25	2,5	rosso	6 NR	2,23
16704	25	4	giallo	6 NR	2,76

Cinghia Ancoraggio



grande in polipropilene stabilizzato con fibbia in alluminio. Carico di rottura ad anello chiuso 700 Kg.

cod.	mm.	mt.	col.	UM	€
16705	35	4	nero-rosso-blu	6 NR	7,66

Cinghia Ancoraggio



super in polipropilene stabilizzato ad alta tenacità, con fibbia in alluminio e crick tenditore di grande portata. Carico di rottura ad anello chiuso 1000 Kg.

cod.	mm.	mt.	col.	UM	€
16706	25	4	arancio	7 NR	6,57

Cinghia Ancoraggio



Espositore pz.27 - Composto da Pz.10 cod.16702 pz.5 cod.16703 pz.5 cod.16704 pz.3 cod.16705 pz.4 cod.16706

cod.	UM	€
16701	1 NR	64,39

Fascia Sollevamento



Nastro 100% poliestere - Certificato di conformità Ue - EC 89/392 CEE EN 1492

cod.	mt.	kg	col.	UM	€
91164	2	1000	viola	1 NR	7,06
91166	4	1000	viola	4 NR	12,37
91167	2	2000	verde	6 NR	12,21
53702	3	2000	verde	6 NR	17,11
53703	4	2000	verde	4 NR	22,62
53704	5	2000	verde	1 NR	27,87
08593	6	2000	verde	1 NR	33,00
91256	2	3000	giallo	4 NR	17,88
91168	3	3000	giallo	4 NR	26,12
53057	4	3000	giallo	1 NR	33,90
53705	5	3000	giallo	2 NR	42,30
91169	6	3000	giallo	1 NR	50,27
53706	4	4000	grigio	2 NR	45,41
91359	6	4000	grigio	2 NR	70,14

Scala 2 Rampe



in alluminio Portata Kg.150. Montanti in alluminio estruso zigrinato 84x25 mm. Articolazione in acciaio zincato per posizione a portafoglio.
Corda antiapertura: dispositivo di sicurezza in materiale ad alta tenuta.
Tirante antiapertura in alluminio con gancio di bloccaggio a chiusura rapida.
Barra stabilizzatrice: dispositivo antiscivolo progettato per garantire la massima aderenza a diversi terreni.

sv	gr	UM	€
07662 4,56	10	1 NR	177,63
10154 5,69	12	1 NR	243,78
07663 6,83	14	1 NR	281,74

Scala Telescopica



in acciaio Portata kg.100. Cerniera di bloccaggio munita di dispositivo di sicurezza antiapertura e antichiusura semiautomatico.
Gradino interno ed esterno a forma trapezoidale che consente in fase di utilizzo una posizione comoda, perfettamente piana e parallela a terra.
Piedini antiscivolo, bloccati alla spalla con fissaggio a blocco.

mt	gr	UM	€
87252 3,77	4+4	1 NR	75,11
87253 4,29	4+5	1 NR	87,93

Scala 3 Rampe



in alluminio, Portata kg.150. Montanti in alluminio estruso zigrinato 84x25 mm. Articolazione semplice e articolazione composta in acciaio zincato per posizione a portafoglio e per sfilo del terzo tronco.
Corda antiapertura: dispositivo di sicurezza in materiale ad alta tenuta.
Tirante antiapertura in alluminio.

sv	gr	UM	€
07664 5,13	8	1 NR	202,13
07665 6,25	10	1 NR	276,24
07666 7,96	12	1 NR	366,28
07667 8,53	14	1 NR	439,78

Scala Telescopica professionale



In alluminio estruso, portata kg.150. Articolazione in acciaio stampato con venature di rinforzo, ad alta resistenza. Paracoli con bordi arrotondati e manopola ergonomica, impugnatura facile e perni in acciaio. Gancio per blocco con anima interna in acciaio rivestito in plastica robusto e resistente, Impugnatura comoda.
Gradino mm.30x30 con zigrinatura antiscivolo e profilo arrotondato ed ergonomico; coprigradino dotato di alette interne di rinforzo per un bloccaggio stabile.
Piedini interno in gomma naturale SBS ergonomico per permettere il massimo appoggio al terreno. Piedino esterno in bicomponente che fornisce alta aderenza antiscivolo e massima stabilità. Predisposizione per portaruote integrato. Certificazione EN 131 D.Lgs.81/08

mt	gr	UM	€
16557 4,96	4+4	1 NR	251,55
16558 6,042	5+5	1 NR	308,63
16559 7,124	6+6	1 NR	393,05
16560 8,206	7+7	1 NR	451,86

Scala 3 Rampe



in alluminio Portata kg.150. Tirante e corda antiapertura-ganci regolazione altezza, Dispositivo antisfilo, Piedino-barra stabilizzatrice antiscivolo

sv	gr	UM	€
88053 3,99	3x7	1 NR	161,81
88054 4,80	3x8	1 NR	182,26
88775 5,61	3x9	1 NR	217,28
89367 5,89	3x10	1 NR	241,33

Scala Edilizia



in ferro tubolare

mt	UM	€
50359 2,5	1 NR	38,03
50360 3	1 NR	45,64
50361 3,5	1 NR	53,24
50362 4	1 NR	60,85
50364 5	1 NR	76,06

Scala Telescopica



in alluminio Portata kg.150. Struttura solida con l'aggiunta di rinforzi in alluminio. Nuovi montanti più larghi con un nuovo profilo stondato. Nuovo gradino più largo 30x30 mm. Nuova manopola dal design innovativo. Nuovo gancio, più grande per una presa più sicura. Nuovo piedino in due componenti. Nuovo coprigradino e coprimontante dalla linea arrotondata. Prodotto MADE IN ITALY in ogni componente.
Certificato EN131 per tutti i modelli in gamma.

mt	UM	€
88657 3,77 media	1 NR	193,32
88658 4,30 super	1 NR	206,72
88659 4,82 gigante	1 NR	237,57

Piedini per Scale



in gomma

mod	UM	€
10556 artiglio	1 NR	2,65
10557 pera	1 NR	2,15

Torre Mobile Gigante



Montanti in tubo tondo di acciaio di diametro 42 mm. Pioli montante in tubo di acciaio ovale 30x15 mm. Base con quattro livellatori a vite con piattello diametro 100 mm. Sistema rapido di fissaggio tiranti con automatismo antisfilo involontario
 Ruote girevoli diametro 150mm di cui due con freno. Piano di lavoro in due pezzi con botola e fermapiadi anticaduta oggetti sui quattro lati. La finitura superficiale della struttura e di tutti i particolari è realizzata con zincatura elettrolitica anticorrosione atmosferica

- Kit alzata completa da mt.1,6: Pz.2
- Dim.esterna torre: Mt.0,93x1,78
- Base completa: 1
- Altezza torre: Mt.3,60
- Kit ancoraggio a parete: 1
- Coppia parapetti protezione laterale: 1
- Piani completo: 1 - Dim.piano: Mt.0,84x1,67
- Altezza max.piano: 2,55
- Portata: Kg.150
- Numero staffe stabilizzatrici: 4 Optional

mod	UM	€
10744	1 NR	1091,80

Kit Alzata per Torre Mobile

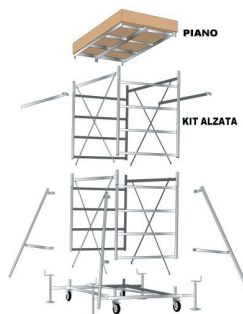

da mt.1,6. L'alzata può essere aggiunta per ottenere altezze maggiori consentite.

mod	UM	€
10745 gigante	1 NR	203,82
10748 maxi	1 NR	225,93

Rampa di Carico



in alluminio fissa

mt.	Portata Kg.	UM	€
12987 2	240	1 NR	129,28
12988 2,5	175	1 NR	155,48
12989 3	110	1 NR	186,33

Rampa di Carico



in alluminio richiudibile

mt.	Portata Kg.	UM	€
12991 2	250	1 NR	184,00
12992 2,5	150	1 NR	208,47
12993 3	100	1 NR	228,26

Torre Mobile Maxi



Montanti in tubo tondo di acciaio di diametro 42 mm. Pioli montante in tubo di acciaio ovale 30x20 mm. Base con quattro livellatori a vite con piattello diametro 160 mm. Sistema rapido di fissaggio tiranti con automatismo antisfilo involontario
 Ruote girevoli diametro 200mm di cui due con freno. Piano di lavoro in due pezzi con botola e fermapiadi anticaduta oggetti sui quattro lati. La finitura superficiale della struttura e di tutti i particolari è realizzata con zincatura elettrolitica anticorrosione atmosferica

- Kit alzata completa da mt.1,6: Pz.2
- Dim.esterna torre: Mt.0,95x2
- Base completa: 1
- Altezza torre: Mt.3,62
- Kit ancoraggio a parete: 1
- Coppia parapetti protezione laterale
- Piani completo: 1 - Dim.piano: Mt.0,84x1,89
- Altezza max.piano: 2,56
- Portata: Kg.200
- Numero staffe stabilizzatrici: 4 Optional

mod	UM	€
10747	1 NR	1460,96

Trabattello Paspertù



CERTIFICAZIONE NF E85/200 per uso trabattello e EN131 1 2 3 4 per uso scala, CONFORME al D.Lgs 81/08 - 4 CONFIGURAZIONI di utilizzo possibili: TRABATTELLO, SCALA DA APPOGGIO, SCALA A PORTAFOGLIO, POSIZIONE A CAVALLETTO. Esclusivi dispositivi di bloccaggio-sbloccaggio rapidi e sicuri. Sistema di aggancio-sgancio ad espansione per i tiranti. Sistema antibalzo con barre stabilizzatrici. PIANO DI LAVORO in legno euro deck multistrato, rinforzato e CON BOTOLA per accesso dall'interno.

- Portata Kg.150
- Altezza massima piano cm.181
- Dimensione cm.272x141x90
- Peso Kg.23,5

mod	UM	€
12985	1 NR	457,69

Piano per Torre Mobile

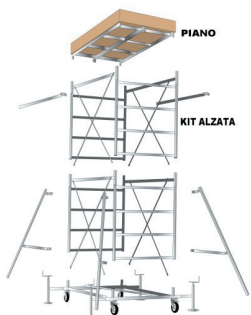

in due pezzi 1 con botola e 1 senza botola con struttura portante in acciaio e fermapiadi anticaduta oggetti sui 4 lati

mod	UM	€
10746 gigante	1 NR	262,04
10749 maxi	1 NR	320,85

Trabattello acciaio zincato



Montanti in tubo di acciaio tondo - Piano di lavoro in legno incluso 120x38 cm. - Con ruote per facilitare lo spostamento - Altezza totale 170 cm. - Altezza al piano di calpestio 120 cm., Dimensioni cm.63x133x170H Portata Kg.100

mod	UM	€
93992	1 NR	80,37

Cavalletto Ferro



doppio cm.100x200

Articolo	UM	€
53025	1 NR	38,82

Foglia Polietilene



spessore 0,20

Articolo	mt	UM	€
50504	2	50 KG	3,54
11973	3	50 KG	3,54
50506	4	50 KG	3,54
13550	5	50 KG	3,54
50508	6	50 KG	3,54
50509	8	50 KG	3,54
50510	10	50 KG	3,54

Foglia Polietilene



trasparente da mq.80-spessore 100 micron

Articolo	mis	UM	€
10759	4x20	2 NR	45,45

Foglia polietilene



trasparente da mq.40 spessore 80 micron

Articolo	mis	UM	€
15260	4x10	6 NR	18,35

Film estensibile



in bobina H.cm.50

Articolo	film	UM	€
02602	film	6 NR	8,94
02603	avvolgitore	1 NR	7,42

Telone Occhiellato



in polietilene a doppia laminazione, Resistente alle basse temperature (-40°C), Stabilizzato ai raggi UV, impermeabile, lavabile, antistrappo, Angoli rinforzati con robusti occhielli in policarbonato, Cordino di rinforzo perimetrale

Articolo	mt	gr/mq	UM	€
80361	2X3	110	20 NR	6,26
80210	3X4	110	10 NR	12,47
80211	4X4	110	12 NR	16,63
80212	5X4	110	9 NR	20,79
80213	6X4	110	4 NR	24,95
80381	6X5	110	4 NR	31,20
80214	6X8	110	4 NR	49,90
80215	6X10	130	3 NR	66,53
85945	8X12	130	2 NR	106,44
85946	10X12	130	1 NR	133,06

Telone Occhiellato Atossico



In polietilene a doppia laminazione 200gr./mq - Resistente alle basse temperature (-40°)
- Trattamento contro i raggi UV - Impermeabile, lavabile, antistrappo - Robusti occhielli in policarbonato - Angoli rinforzati - Cordino di rinforzo perimetrale.

Articolo	mt	UM	€
88186	4x6	3 NR	40,16
88187	6x8	2 NR	80,37
93796	8x12	1 NR	160,76

Telone Occhiellato Retinato



Utilizzo multiuso per coperture esterne, tende balcone, rimessaggio, ecc. - Foglio laminato da 140 gr./mq. - UV stabilizzato - Corda di rinforzo perimetrale - Occhioli ogni 25 cm. sui 4 lati - Resistente al vento e al gelo - Impermeabile - Facile da installare - Confezione in busta

Articolo	mt	UM	€
91898	3x1,9	1 NR	8,51
91900	3x3	1 NR	13,44
91901	3x4	1 NR	17,92
91902	3x5	1 NR	22,41

Pluriball

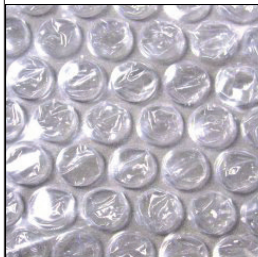

altezza mt.1 lunghezza mt.18 gr.70

Articolo	UM	€
05494	8 RT	14,62

Pluriball



cm.40 mt.4 in box da 30 sacchetti



Articolo	UM	€
15268	1 CF	87,80

Pluriball



altezza mt.1 lunghezza mt.10 in box da 20 bobine

14667

1 UM
CF € 157,88

Cartone Canettato

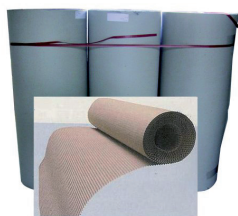

altezza mt.1 in rotolo mt.30

mod	gr./mq.	UM	€
08811 pesante	500	12 RT	38,66
12587 leggero	235	24 NR	24,04

Nastro antiscivolo in Rotolo



colore nero. Particolarmente indicati su superfici scivolose, inclinate o pericolose. Di facile applicazione. Grazie alla loro elevata impermeabilità e resistenza possono essere impiegati sia in ambienti interni che esterni.

mm	mt	UM	€
10530 25	18	1 NR	16,22

Nastro antiscivolo



colore nero in blister pz.5, adesivo particolarmente indicati su superfici scivolose, inclinate o pericolose. Di facile applicazione. Grazie alla loro elevata impermeabilità e resistenza possono essere impiegati sia in ambienti interni che esterni.

mm	cm	UM	€
10531 19	61	1 BL	5,18